

Trennstelle  
SEPARATING POINT  
POINT DE SEPARATION  
PUNTO DI SEPARAZIONE

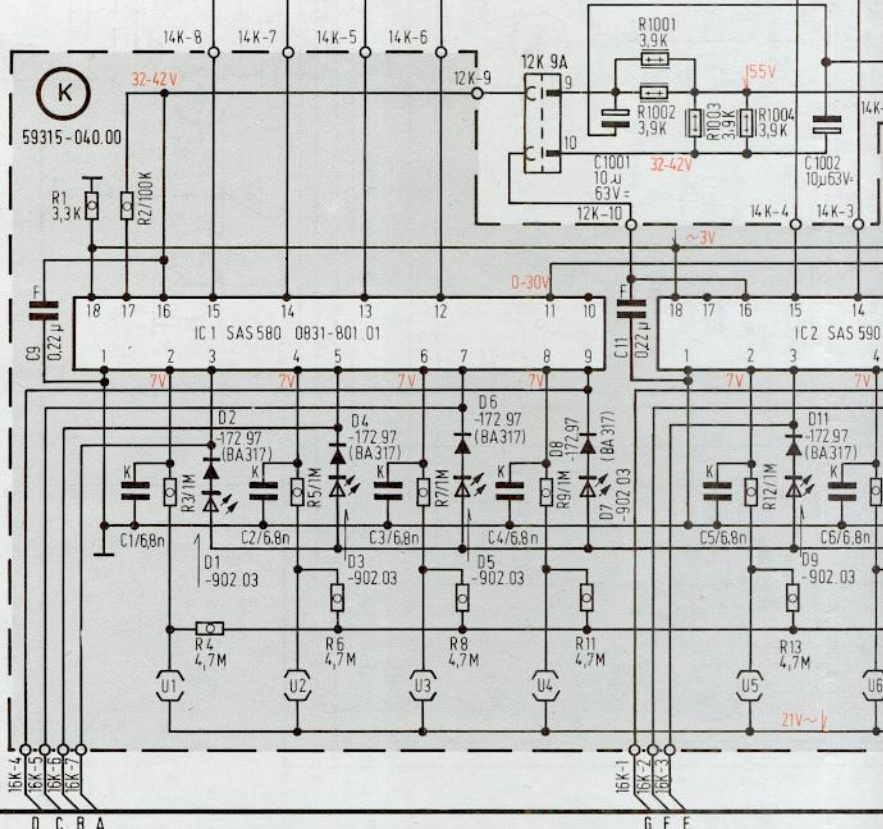

C	251, 253,	9, 301, 302, 300, 1,	2, 303,	304, 3, 307, 305, 306,	4, 308, 309, 1001, 311, 312,	313, 314, 6, 315, 1002.
R	259, 261,	1, 301, 2, 3, 4, 302,	303, 5, 6, 304,	305, 7, 8, 306,	307, 309, 11, 1001, 312, 314, 311, 1002, 1003,	315, 14, 12,

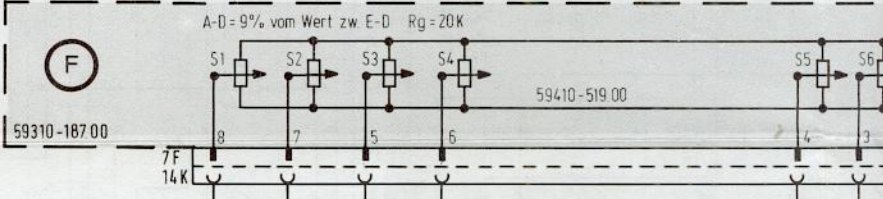
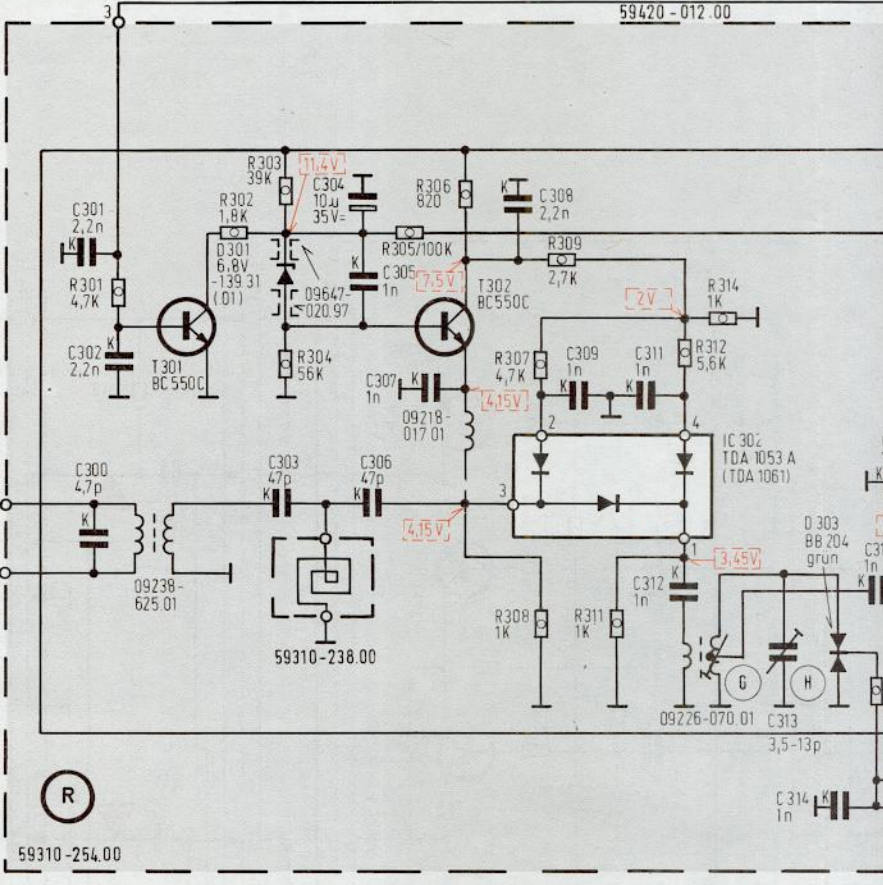
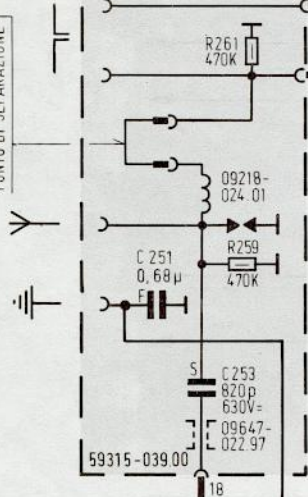
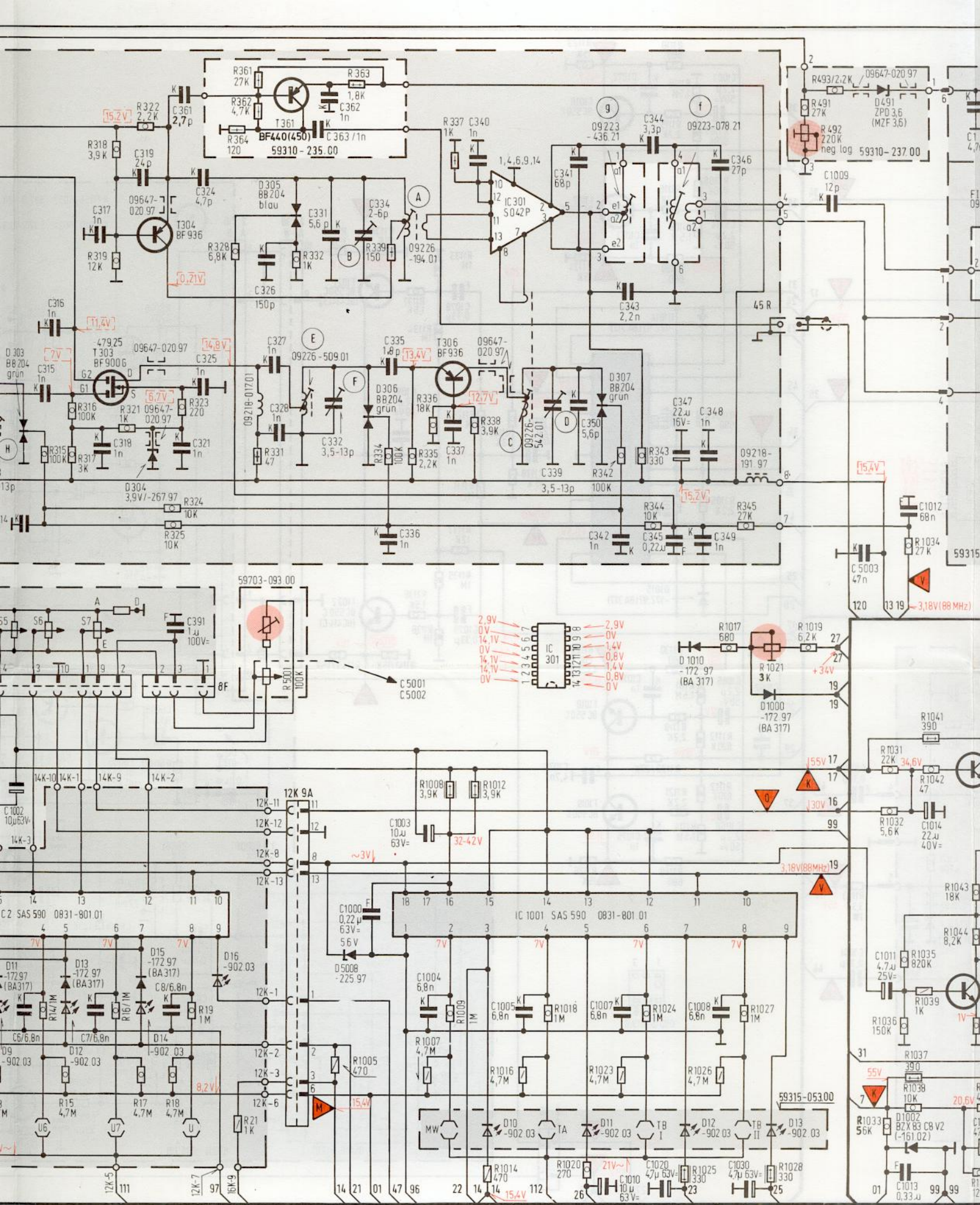

314, 6, 315, 316, 1002	317, 318, 7,	319,	391, 321, 324, 8, 361, 325,	326, 327, 328,	362, 331, 363, 332,	334, 1000, 336,	335, 1004,	1003, 337, 340,	1005, 339, 1006, 341, 350,	342, 343, 344, 1007,	345, 347, 349, 348, 1020, 1008, 346,	1030,	1009, 5003, 1011, 1012, 1014, 1013,	1015,
3, 315, 316, 14, 317, 15,	318, 321, 17, 319, 16,	322, 323, 324, 18, 325, 19,	328, 331, 21, 361, 362,	332,	1005, 363, 339, 334,	335, 336, 1008, 337, 338, 1007, 1009,	1010, 1012, 1014,	1020, 342, 343, 344, 1025, 1016, 1018,	1026, 345, 1028, 1017, 1027, 1021,	491, 493, 492, 1019,	1033, 1034, 1037, 1041, 1043, 1031, 1035, 1038, 1042, 1044, 1032, 1036, 1039, 1045,	1046,	1047, 1048, 1049, 1050,	1051,

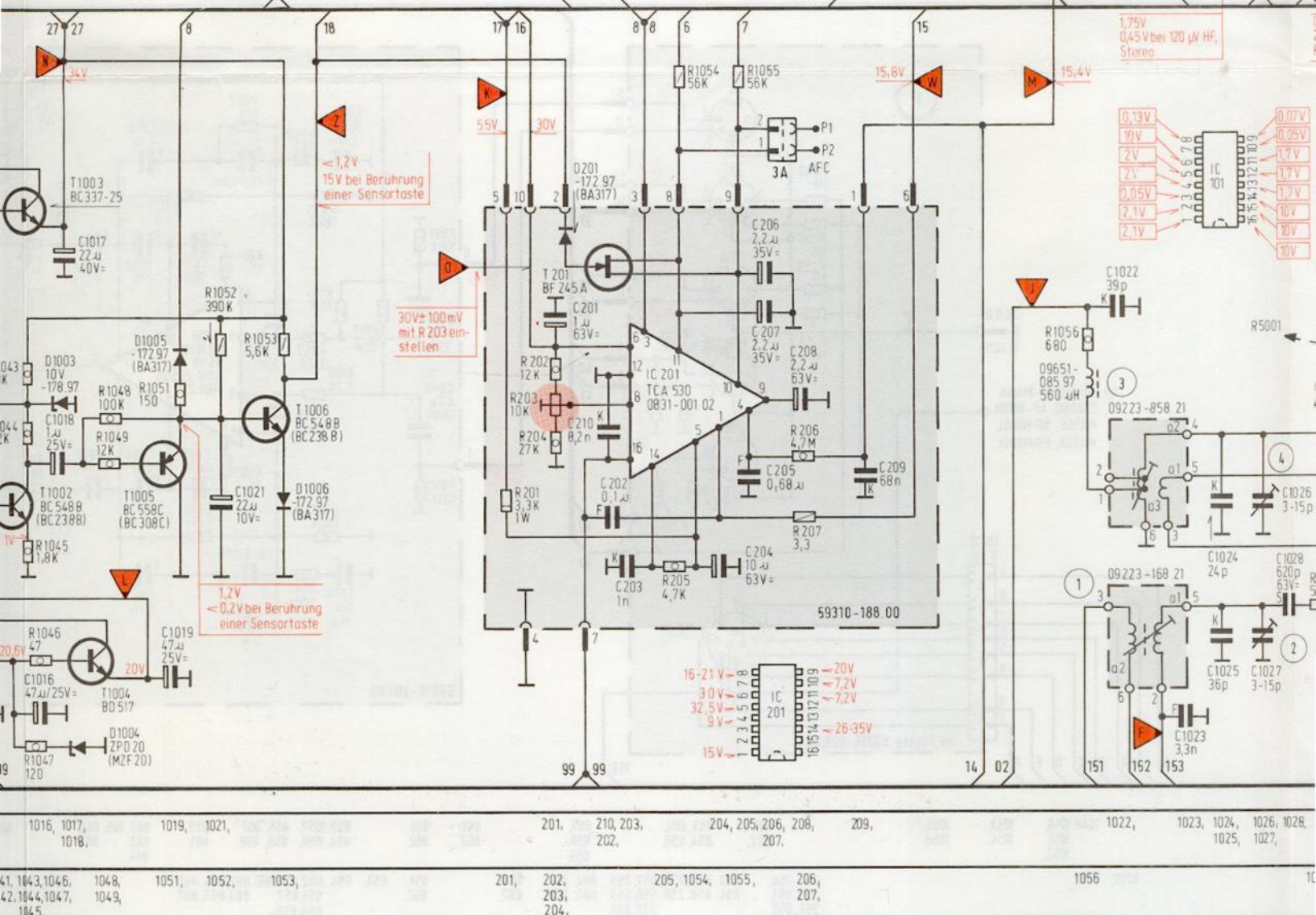
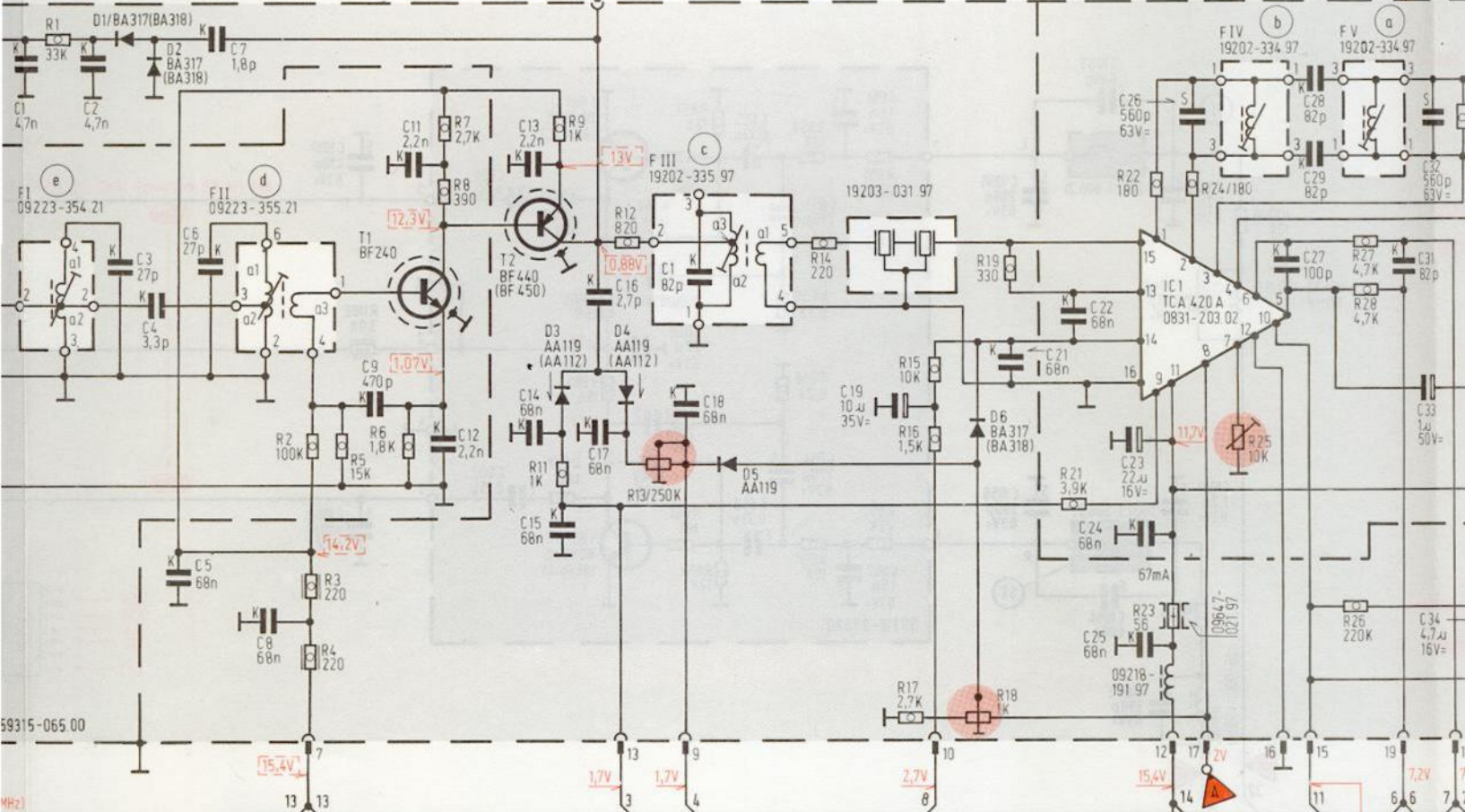

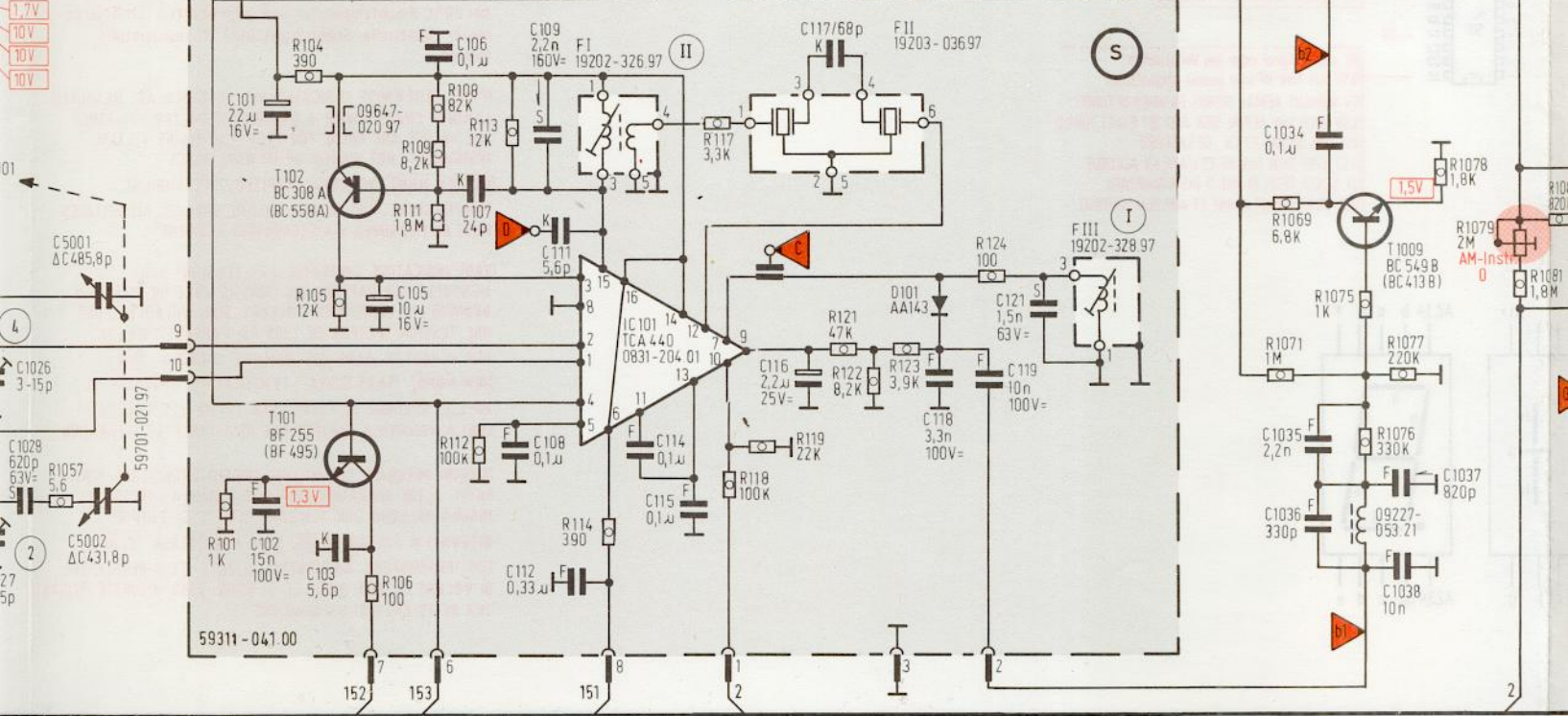
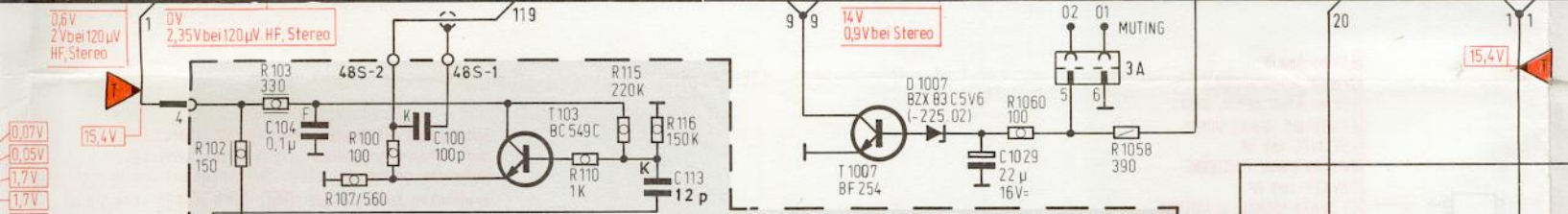
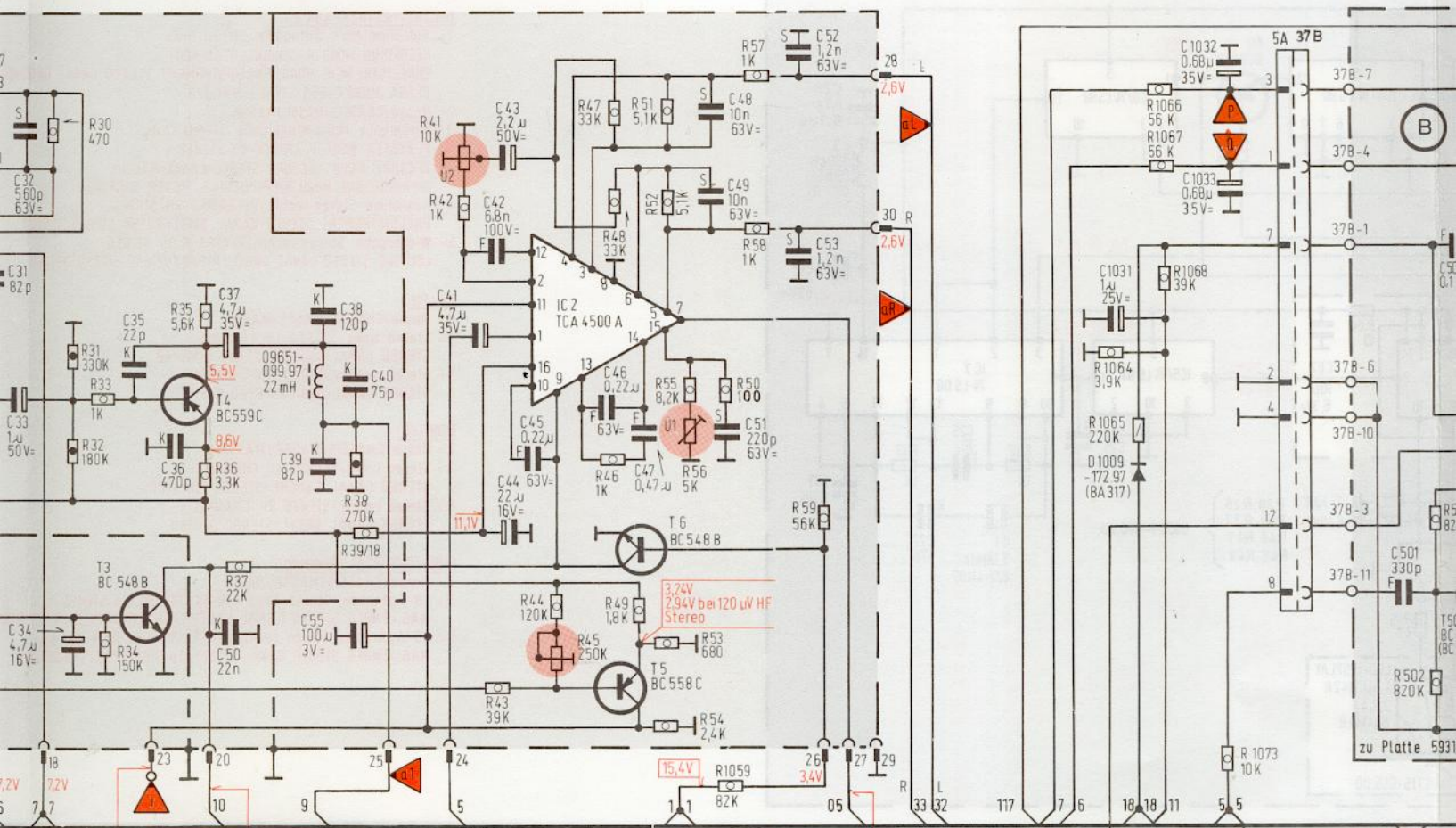

6, 1028, 7,	5001, 5002,	101, 102,	103, 104,	105, 106,	107, 108,	109, 110, 111,	112, 113,	110, 114, 115, 116,	117, 118,	119, 1059, 121, 122, 123,	124,	1060,	1058,	1064, 1065,	1066, 1069, 1073, 1075, 1077, 1078,	1079, 1081,	105, 501, 502,
-------------	-------------	-----------	-----------	-----------	-----------	----------------	-----------	---------------------	-----------	---------------------------	------	-------	-------	-------------	-------------------------------------	-------------	----------------

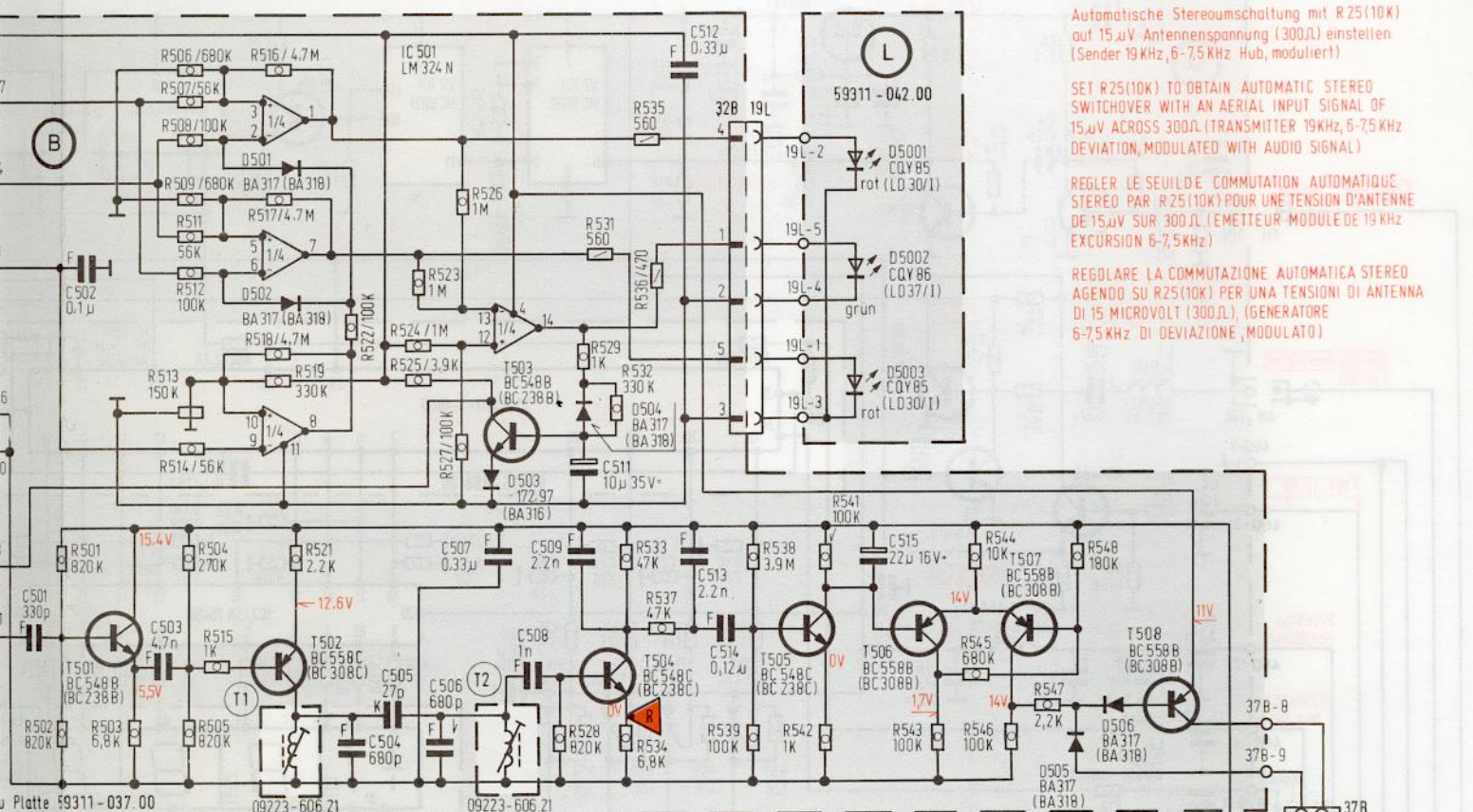

Automatische Stereumschaltung mit R25(10K) auf 15µV Antennenspannung (300Ω) einstellen (Sender 19KHz, 6-7,5KHz Hub, moduliert)

SET R25(10K) TO OBTAIN AUTOMATIC STEREO SWITCHOVER WITH AN AERIAL INPUT SIGNAL OF 15µV ACROSS 300Ω (TRANSMITTER 19KHz, 6-7.5KHz DEVIATION, MODULATED WITH AUDIO SIGNAL)

REGLER LE SEUILLE COMMUTATION AUTOMATIQUE STEREO PAR R25(10K) POUR UNE TENSION D'ANTENNE DE 15µV SUR 300Ω (EMETTEUR MODULE DE 19KHz EXCURSION 6-7,5KHz)

REGOLARE LA COMMUTAZIONE AUTOMATICA STEREO AGENDO SU R25(10K) PER UNA TENSIONI DI ANTENNA DI 15 MICROVOLT (300Ω), (GENERATORE 6-7,5KHz DI DEVIAZIONE, MODULATO)

< 0.2V bei FM und AM  
20V bei TA, TB11, 12V bei TB1

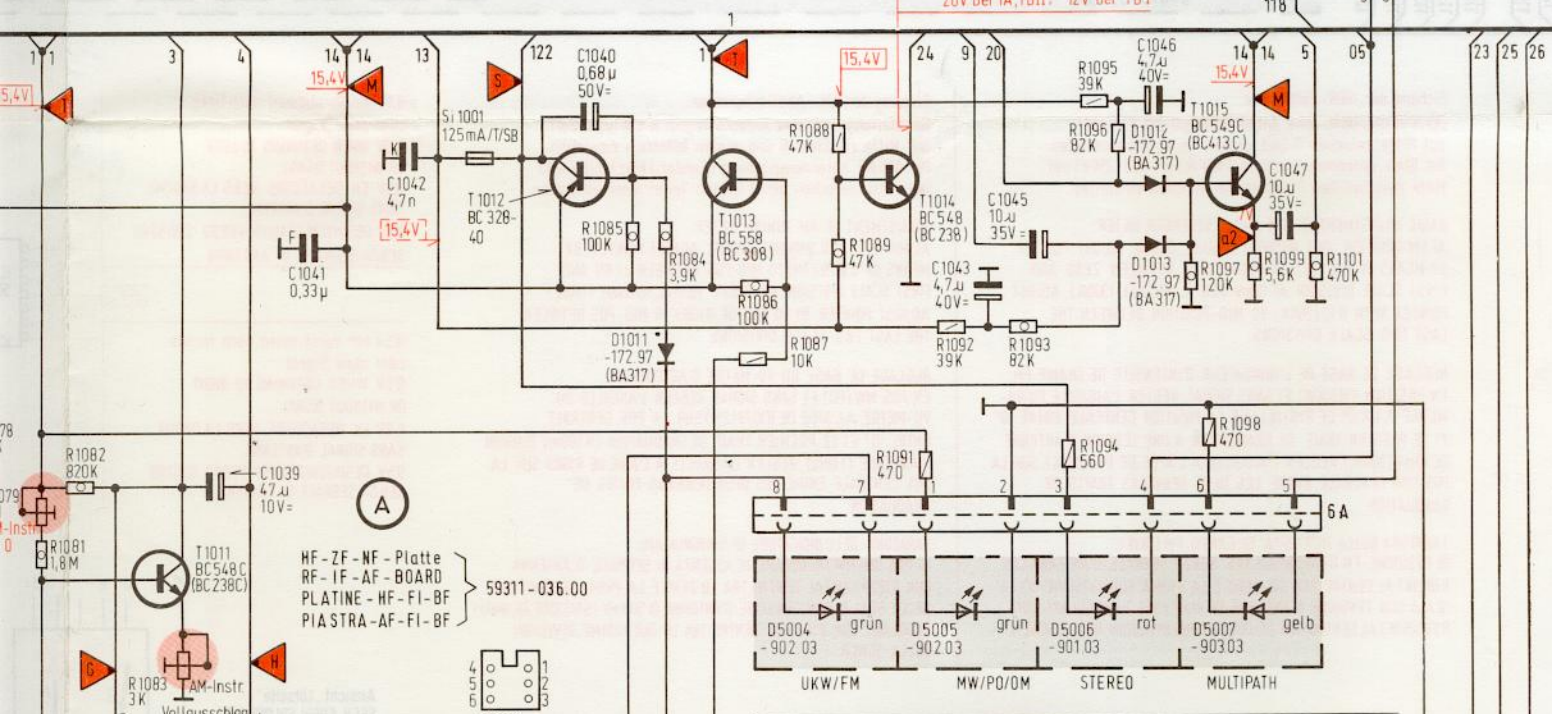

**GRUNDIG**

**Hi Fi**

**PreCeiver X 55**

(50019-906.04)

Teil 1 99 99 23 25 26

55017-942.00

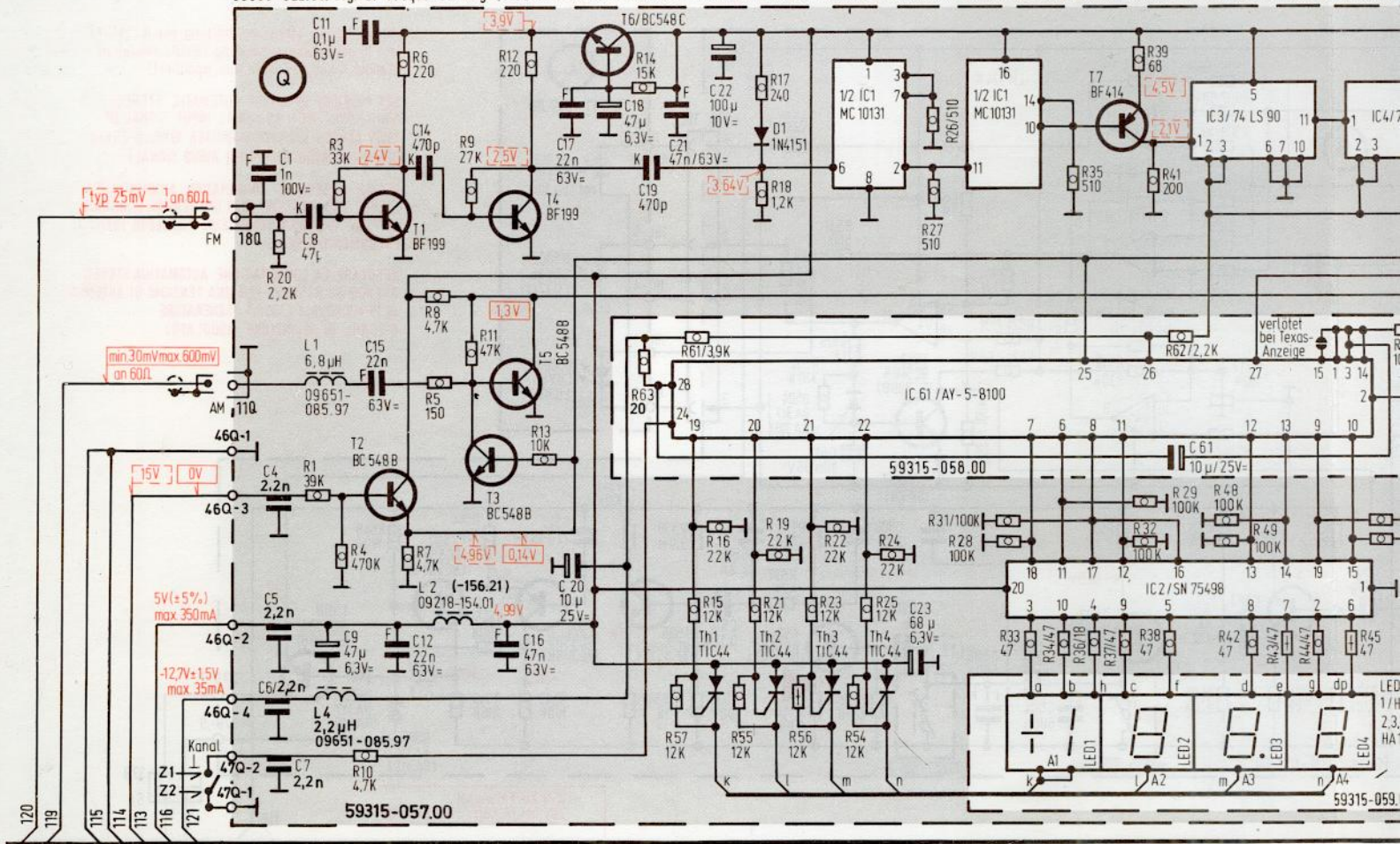

**Eichung der UKW-Feldstärke:**

Bei Stellung UKW, ohne Antennensignal mit R18 (1K) auf Mitte zwischen 0 und ersten Teilstrich einstellen. Bei 10mV Antennenspannung (300Ω) mit R13 (250K) auf Mitte zwischen den 2 letzten Teilstrichen einstellen.

**BASIC ADJUSTMENT OF FM FIELD STRENGTH METER:**  
AT FM POSITION AND WITHOUT AERIAL SIGNAL, ADJUST POINTER BY MEANS OF R18 (1K) TO MID-POSITION BETWEEN ZERO AND FIRST SCALE DIVISION. AT 10mV AERIAL VOLTAGE (300Ω), ADJUST POINTER WITH R13 (250K) TO MID-POSITION BETWEEN THE LAST TWO SCALE DIVISIONS.

**REGLAGE DE BASE DE L'INDICATEUR D'INTENSITE DE CHAMP FM:**  
EN POSITION FM (UKW) ET SANS SIGNAL, REGLER L'AIGUILLE DU VU-METRE A L'AIDE DE R18 (1K) SUR LA POSITION CENTRALE ENTRE "0" ET LE PREMIER TRAIT DE GRADUATION. A UNE TENSION D'ANTENNE DE 10mV (300Ω), REGLER L'AIGUILLE A L'AIDE DE R13 (250K) SUR LA POSITION CENTRALE ENTRE LES DEUX DERNIERS TRAIT DE GRADUATION.

**TARATURA DELLA INTENSITA' DI CAMPO FM (UKW):**  
IN POSIZIONE FM (UKW) REGOLARE SENZA SEGNALE D'ANTENNA CON R18 (1K) AL CENTRO TRA LO ZERO E LA PRIMA SUDDIVISIONE DELLA SCALA CON TENSIONE D'ANTENNA DI 10mV (300Ω). REGOLARE CON R13 (250K) AL CENTRO TRA LE DUE ULTIME DIVISIONI DELLA SCALA.

**Eichung der AM - Abstimmzeige:**

Bei Stellung MW, ohne Antennensignal mit R1079 (2M) auf Mitte zwischen 0 und ersten Teilstrich einstellen. Bei 500mV Antennenspannung (Sender 1MHz) mit R1083 auf Mitte zwischen den 2 letzten Teilstrichen einstellen.

**ADJUSTMENT OF AM TUNING METER:**  
AT MW POS. AND WITHOUT SIGNAL, ADJUST POINTER BY MEANS OF R1079 (2M) TO MID-POS. BETWEEN ZERO AND FIRST SCALE DIVISION. AT 500mV AERIAL VOLTAGE (1MHz) ADJUST POINTER BY MEANS OF R1083 TO MID-POS. BETWEEN THE LAST TWO SCALE DIVISIONS.

**REGLAGE DE BASE DU VU-METRE D'ACCORD AM:**  
EN POS. MW (PO) ET SANS SIGNAL, REGLER L'AIGUILLE DU VU-METRE A L'AIDE DE R1079 (2M) SUR LA POS. CENTRALE ENTRE "0" ET LE PREMIER TRAIT DE GRADUATION. EN 500mV TENSION D'ANTENNE (1MHz), REGLER L'AIGUILLE A L'AIDE DE R1083 SUR LA POS. CENTRALE ENTRE LES DEUX DERNIERS TRAIT DE GRADUATION.

**TARATURA DELL'INDICATORE DI SINTONIA AM:**  
IN POS. OM (MW) REGOLARE, IN ASSENZA DI SEGNALE D'ANTENNA, CON R1079 (2M) AL CENTRO TRA LO ZERO E LA PRIMA SUDDIVISIONE DELLA SCALA. CON TENSIONE D'ANTENNA DI 500mV (STAZIONE DE 1MHz) REGOLARE CON R1083 AL CENTRO TRA LE DUE ULTIME DIVISIONI DELLA SCALA.

9.5V bei Verstärken nach links oder ohne Signal.  
9.5V WHEN DETUNING TO LEFT OR WITHOUT SIGNAL.  
9.5V EN DESACCORD VERS LA GAUCHE SANS SIGNAL D'ANTENNE.  
9.5V DESINTONIZZANDO VERSO SINISTRO SENZA SEGNALE DI ANTENNA.

9.5V bei Verstärken nach rechts oder ohne Signal.  
9.5V WHEN DETUNING TO RIGHT OR WITHOUT SIGNAL.  
9.5V EN DESACCORD VERS LA DROITE SANS SIGNAL D'ANTENNE.  
9.5V DESINTONIZZANDO VERSO DESTRO SENZA SEGNALE DI ANTENNA.



Ansicht „Lötseite“  
SEEN FROM SOLDER SIDE  
VUE DU COTE DES SOUDURES  
VISTA LATO SALDATURA



C	6, 8, 11, 12, 14, 16, 17, 18, 19, 21, 22, 23, 61
R	20, 1, 3, 10, 4, 6, 8, 9, 7, 5, 11, 12, 13, 14, 61, 16, 17, 19, 23, 22, 25, 24, 26, 27, 28, 31, 33, 34, 35, 36, 37, 39, 29, 38, 41, 62, 48, 42, 49, 43, 44, 45, 46, 6, 47

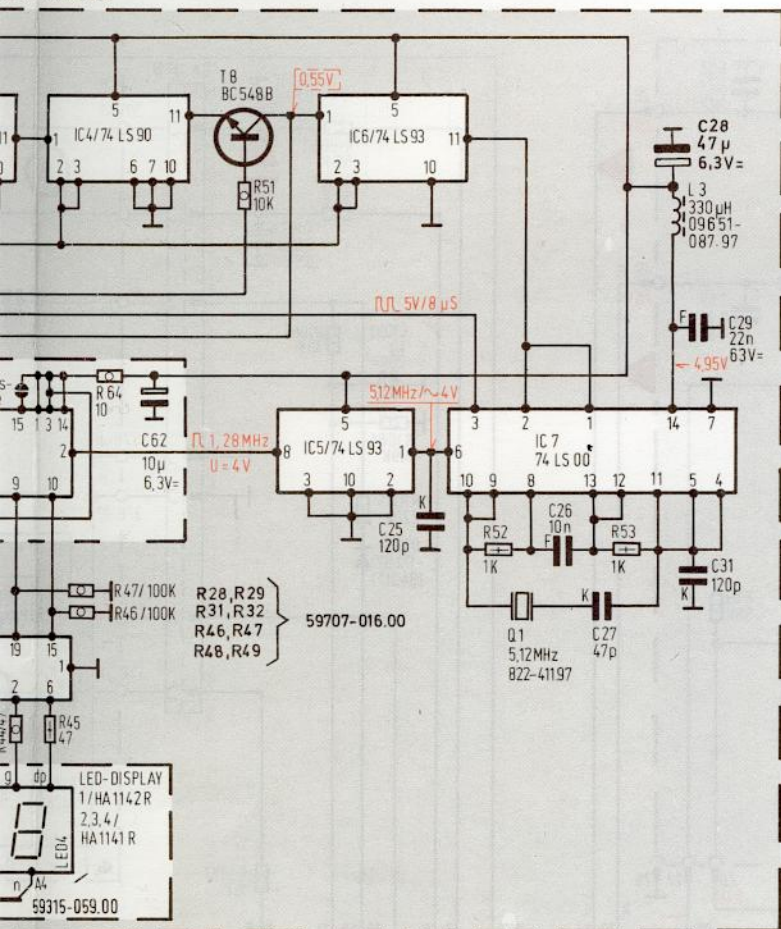

TB1, TB2/TR1, TR2/MAGN 1,2

- 1= Aufnahme Mono, Aufnahme Stereo links  
RECORDING MONO, RECORDING LH STEREO  
ENREGISTREMENT MONO, ENREGISTREMENT STEREO CANAL GAUCHE  
PRESA MONO, PRESA STEREO SINISTRO
- 2= Masse /CHASSIS/MASSE/MASSA
- 3= Wiedergabe Mono, Wiedergabe Stereo links  
PLAYBACK MONO, PLAYBACK LH STEREO  
LECTURE MONO, LECTURE STEREO CANAL GAUCHE  
RIPRODUZIONE MONO, RIPRODUZIONE STEREO SINISTRO
- 4= Aufnahme Stereo rechts/RECORDING RH STEREO  
ENREGISTREMENT STEREO CANAL DROIT/PRESA STEREO DESTRO
- 5= Wiedergabe Stereo rechts/PLAYBACK RH STEREO  
LECTURE STEREO CANAL DROIT/RIPRODUZIONE STEREO DESTRO

TA/PU

- 2= Masse/CHASSIS/MASSE/MASSA
- 3= Stereo links/STEREO LH CHANNEL  
STEREO CANAL GAUCHE/STEREO SINISTRO
- 5= Stereo rechts/STEREO RH CHANNEL  
STEREO CANAL DROIT/STEREO DESTRO

MONITOR

- 2= Masse/CHASSIS/MASSE/MASSA
- 3= Stereo links/STEREO LH CHANNEL  
STEREO CANAL GAUCHE/STEREO SINISTRO
- 5= Stereo rechts/STEREO RH CHANNEL  
STEREO CANAL DROIT/STEREO DESTRO

LINE-UNIVERSAL Ausgang

- 2= Masse/CHASSIS/MASSE/MASSA
- 3= TB-Aufnahme Stereo links / TR-RECORDING LH-STEREO  
MAG-ENREG STEREO CANAL GAUCHE / TB-PRESA STEREO SINISTRO
- 5= TB-Aufnahme Stereo rechts / TR-RECORDING RH-STEREO  
MAG-ENREG STEREO CANAL DROIT / TB-PRESA STEREO DESTRO

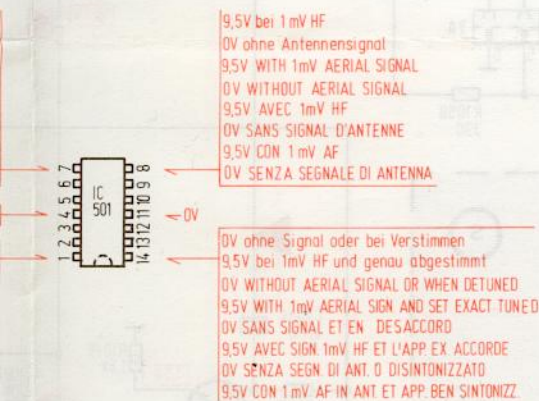

9,5V bei 1mV HF  
0V ohne Antennensignal  
9,5V WITH 1mV AERIAL SIGNAL  
0V WITHOUT AERIAL SIGNAL  
9,5V AVEC 1mV HF  
0V SANS SIGNAL D'ANTENNE  
9,5V CON 1mV AF  
0V SENZA SEGNALE DI ANTENNA

0V ohne Signal oder bei Verstärken  
9,5V bei 1mV HF und genau abgestimmt  
0V WITHOUT AERIAL SIGNAL OR WHEN DETUNED  
9,5V WITH 1mV AERIAL SIGNAL AND SET EXACT TUNED  
0V SANS SIGNAL ET EN DESACCORD  
9,5V AVEC SIGN 1mV HF ET L'APP EX ACCORDE  
0V SENZA SEGN DI ANT O DISINTONIZZATO  
9,5V CON 1mV AF IN ANT ET APP BEN SINTONIZZ

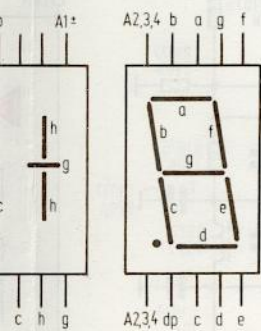

Spannungen mit Grundig-Voltmeter (Ri=10MΩ), falls nicht anders angegeben, gegen Masse gemessen. Meßwerte gelten bei 220V~ Netzspannung und im nicht-erwärmten Zustand auf [MW] [UKW MONO], ohne Signal bei 20°C Raumtemperatur und zugeordnetem Lautstärkeregler. Sämtliche Spannungen über Trennwiderstand messen

IF NOT OTHERWISE INDICATED ALL VOLTAGES ARE MEASURED AGAINST CHASSIS WITH A GRUNDIG VOLTMETER (Ri=10MΩ). THE VALUES ARE VALID FOR 220V~ AC MAINS VOLTAGE INSTRUMENT NOT WARMED UP ON WAVE BANDS [MW] [FM MONO], NO SIGNAL APPLIED, 20°C AMBIENT TEMPERATURE, AND CLOSED VOLUME CONTROL ALL VOLTAGES MUST BE MEASURED VIA SEPARATING RESISTOR

SAUF INDICATION CONTRAIRE, LES TENSIONS SONT MESUREES PAR RAPPORT AU CHASSIS AVEC UN VOLTMETRE GRUNDIG (Ri=10MΩ). LES VALEURS SONT VALABLES POUR UNE TENSION SECTEUR DE 220V CA L'APPAREIL EN ETAT NON-ECHAUFFE, DANS LES GAMMAS D'ONDES [MW] [UKW MONO], SANS SIGNAL, TEMPERATURE AMBIANTE DE 20°C ET REGLAGE DE PUISSANCE FERME. LES TENSIONS SONT A MESURER A TRAVERS UNE RESISTANCE DE SEPARATION

TENSIONI MISURATE CON MILLIVOLTMETRO GRUNDIG (Ri=10MΩ) SAIV ALTRE INDICAZIONI, RIFERITE A MASSA I VOLTORI DI MISURA VALGONO CON TENSIONE DI RETE DI 220V E RILEVATI A FREDDO SU [ME] [UKW MONO], SENSA SEGNALE CON TEMPERATURA AMBIENTALE DI 20°C E COL REGOLATORE DI VOLUME A ZERO TUTTE LE TENSIONI SONO MISURATE MEDIANTE UNA RESISTENZA DI SEPARAZIONE

GAUCHE

ESTRO

STRO

SINISTRO

DESTRO

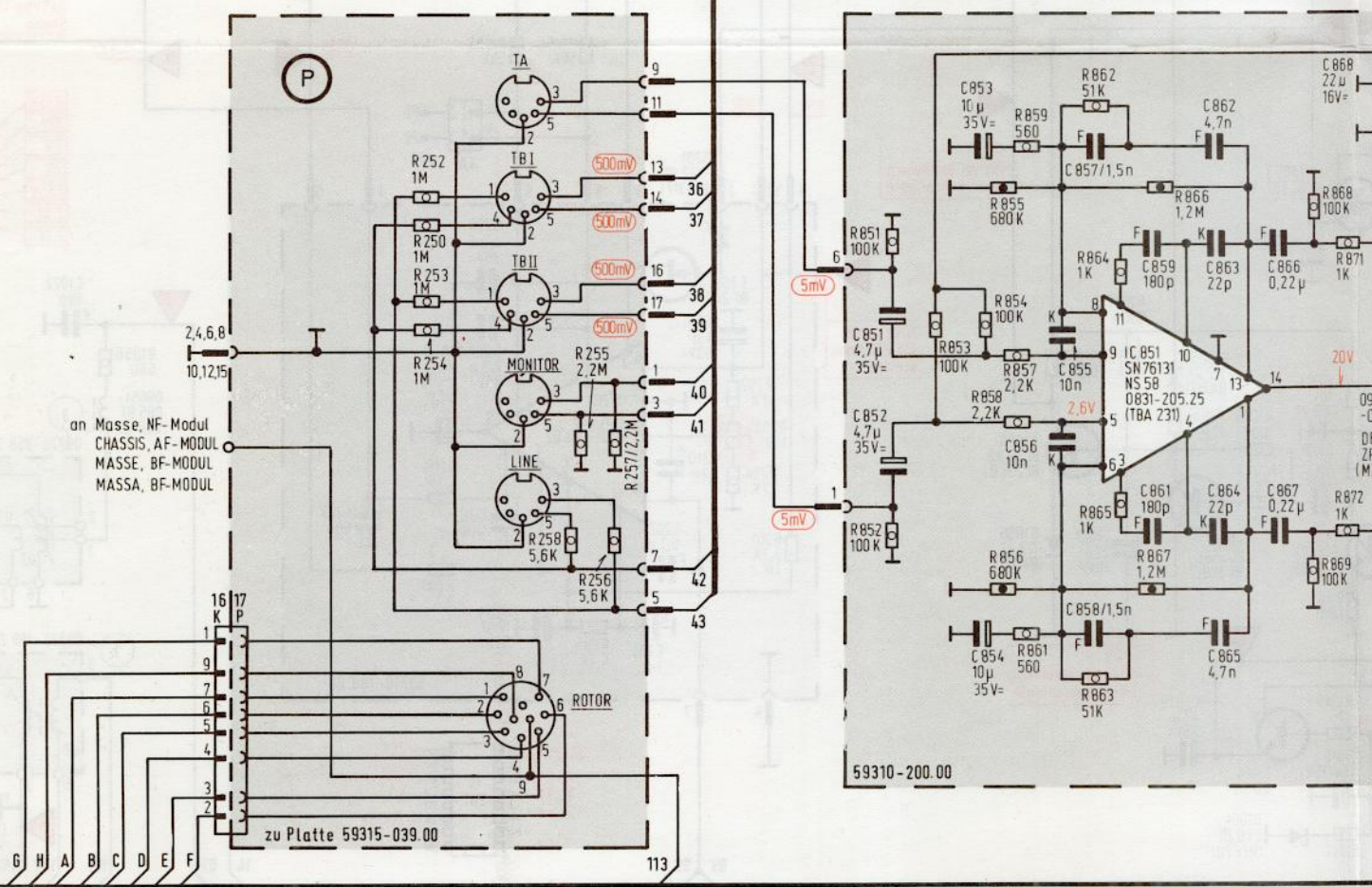
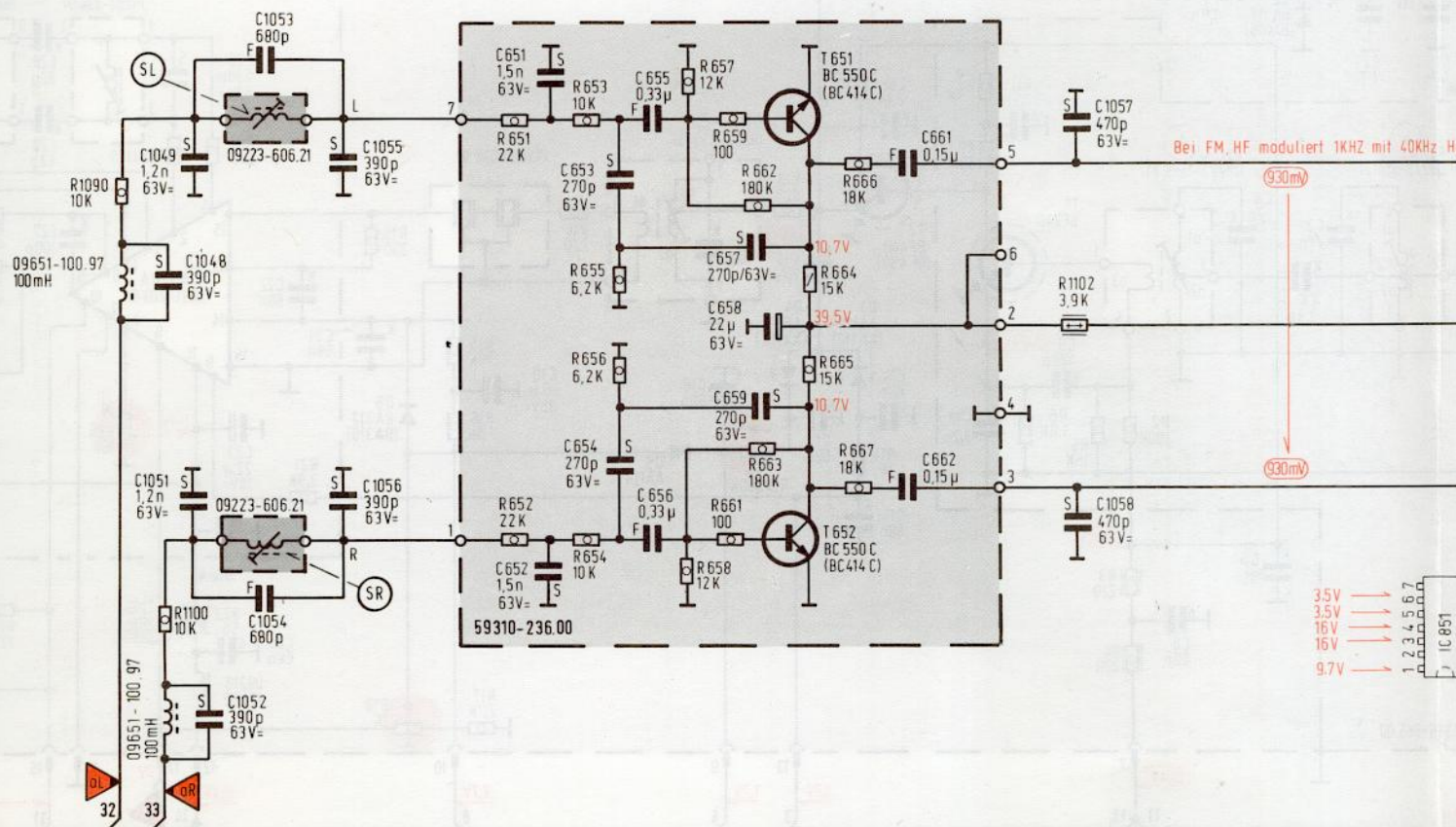

1048, 1049, 1051, 1052,	1053, 1054, 1056,	651, 652,	653, 654, 655, 656,	657, 658, 659,	661, 662,	851, 852,	853, 854, 1057, 1058,	855, 856, 858,	859, 861,	862, 863, 864,	865, 866, 867,	868, 871, 869, 872,
1090, 1100,		252, 254, 250, 251, 253, 252,	653, 655, 255, 657, 258, 654, 656, 258, 656, 659, 257, 661,	662, 664, 663, 665, 667,	851, 852,	853, 854, 1102, 859, 861, 862, 864, 866, 855, 857, 863, 865, 867, 856, 858,						



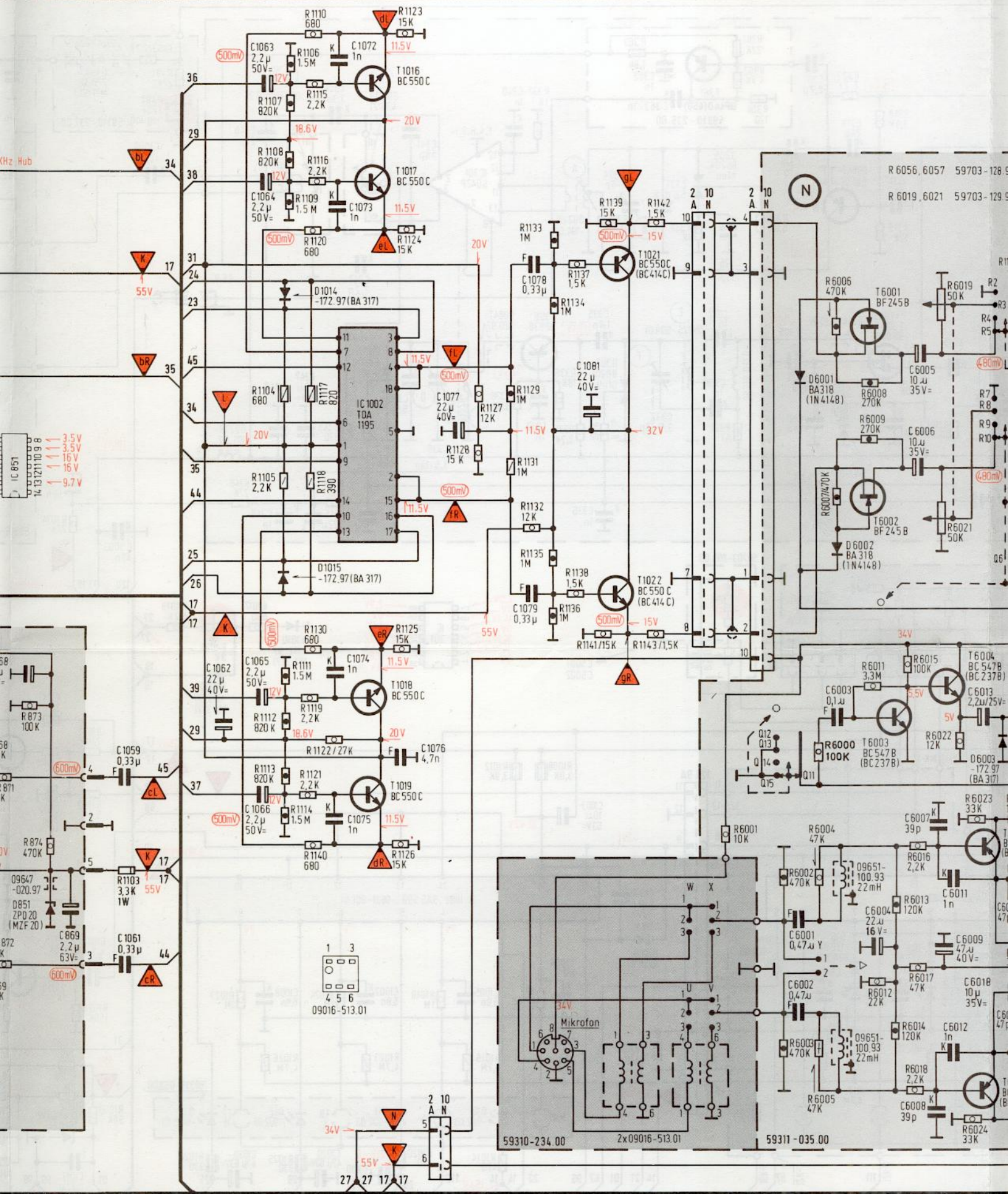

868, 869,	1059, 1061,	1062, 1063, 1066, 1064, 1065,	1072, 1075, 1073, 1074,	1076,	1077,	1078, 1079,	1081,	6001, 6002,	6003, 6004,	6005, 6008, 6012, 6006, 6011, 6013, 6007, 6009,
871, 873, 874, 872,	1103,	1104, 1107, 1111, 1114, 1117, 1121, 1120, 1105, 1108, 1112, 1115, 1118, 1122, 1130, 1106, 1109, 1113, 1116, 1119, 1110, 1140, 1125,	1123, 1126, 1124,	1127, 1128,	1129, 1132, 1133, 1136, 1139, 1131, 1134, 1137, 1141, 1135, 1138,	1142, 1143,	6001,	6002, 6003,	6004, 6006, 6005, 6007, 6000,	6008, 6012, 6015, 6019, 6022, 6009, 6013, 6016, 6021, 6023, 6011, 6014, 6017, 6019, 6024,

59703-128 97 MIKROFON

59703-129 97 MIX

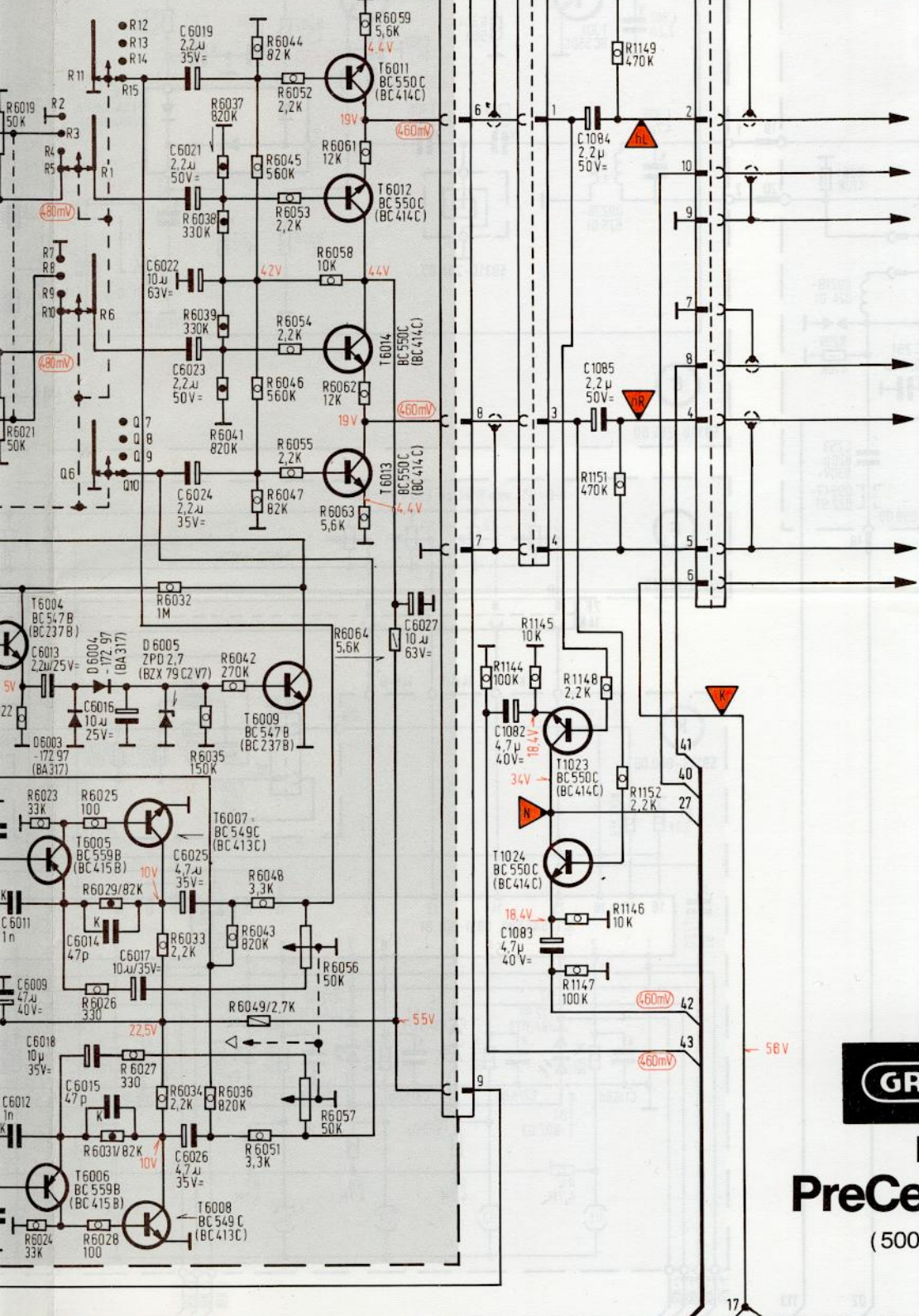

# Hi Fi PreCeiver X 55

(50019-906.04)

Teil 2

6008, 6012, 6011, 6013, 6009,	6014, 6016, 6019, 6023, 6026,	6027,	1082, 1083, 1084, 1085,	22256	030378St
6019, 6022, 6021, 6023, 6018, 6024,	6025, 6028, 6032, 6035, 6038, 6042, 6045, 6048, 6052, 6055, 6058, 6062, 1144,	1145, 1146, 1148, 1149, 1147, 1151, 1152,			
					55017-942.00

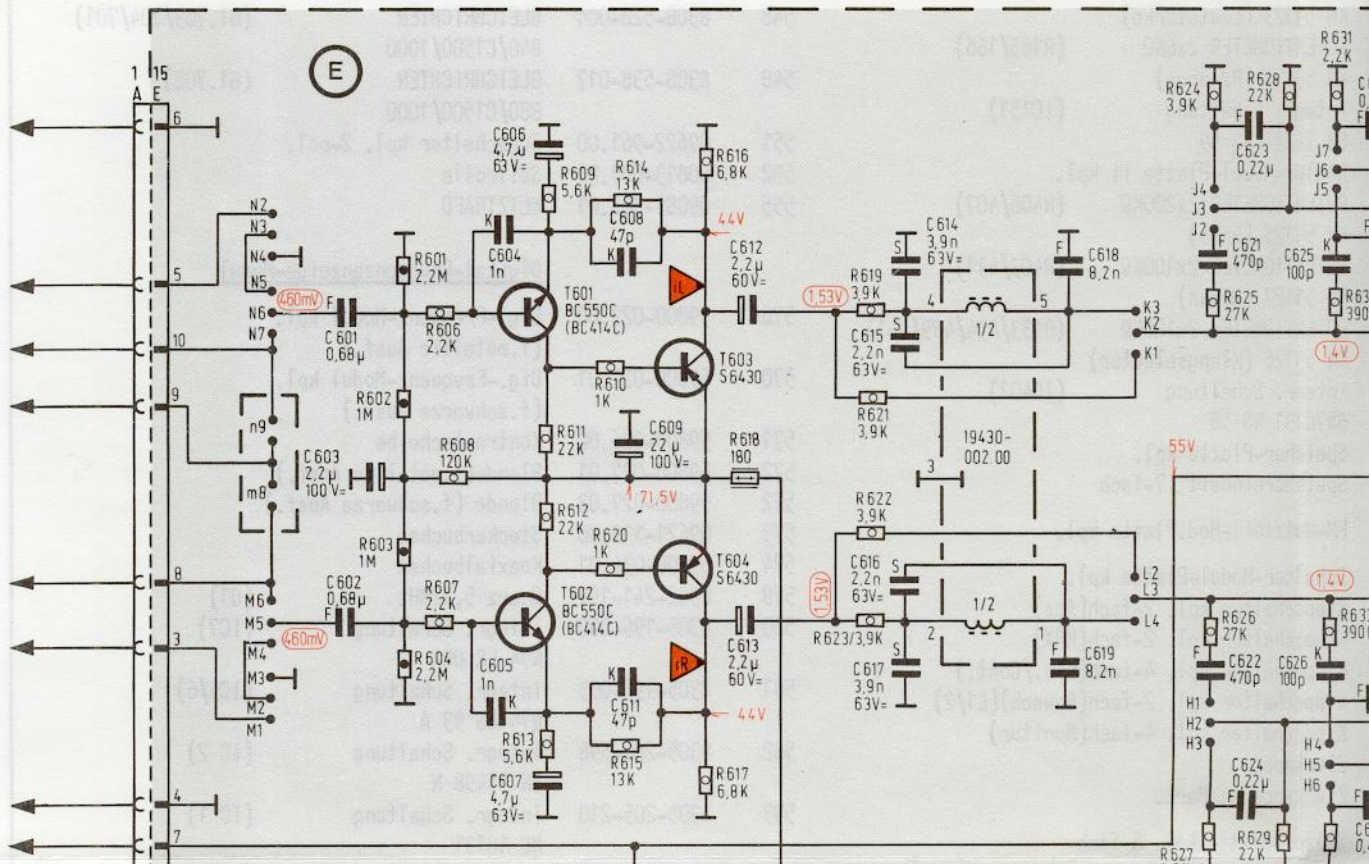

59315-063.00

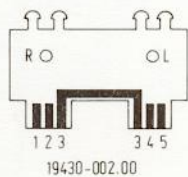

(A) HF-ZF-NF-Platte  
 RF-IF-AF-BOARD  
 PLATINE-HF-FI-BF  
 PIASTRA-AF-FI-BF } 59311-036.00

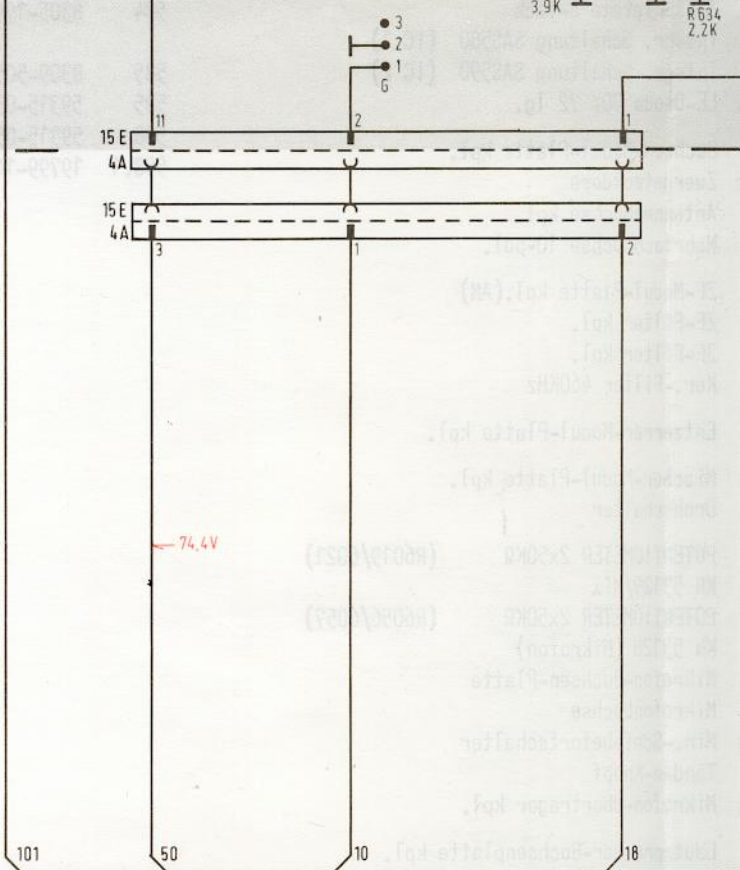

601, 603, 602,	604, 605,	606, 607,	608, 609, 611,	612, 613,	614, 617, 615, 616,	618, 619,	621, 623, 622, 624,	625, 626,
601, 604, 606, 602, 607, 603, 608,	609, 613, 611, 612,	614, 615, 610, 620,	616, 618, 617,	619, 623, 621, 622,	624, 627, 628, 625, 629, 626, 633,	631, 634, 632,		



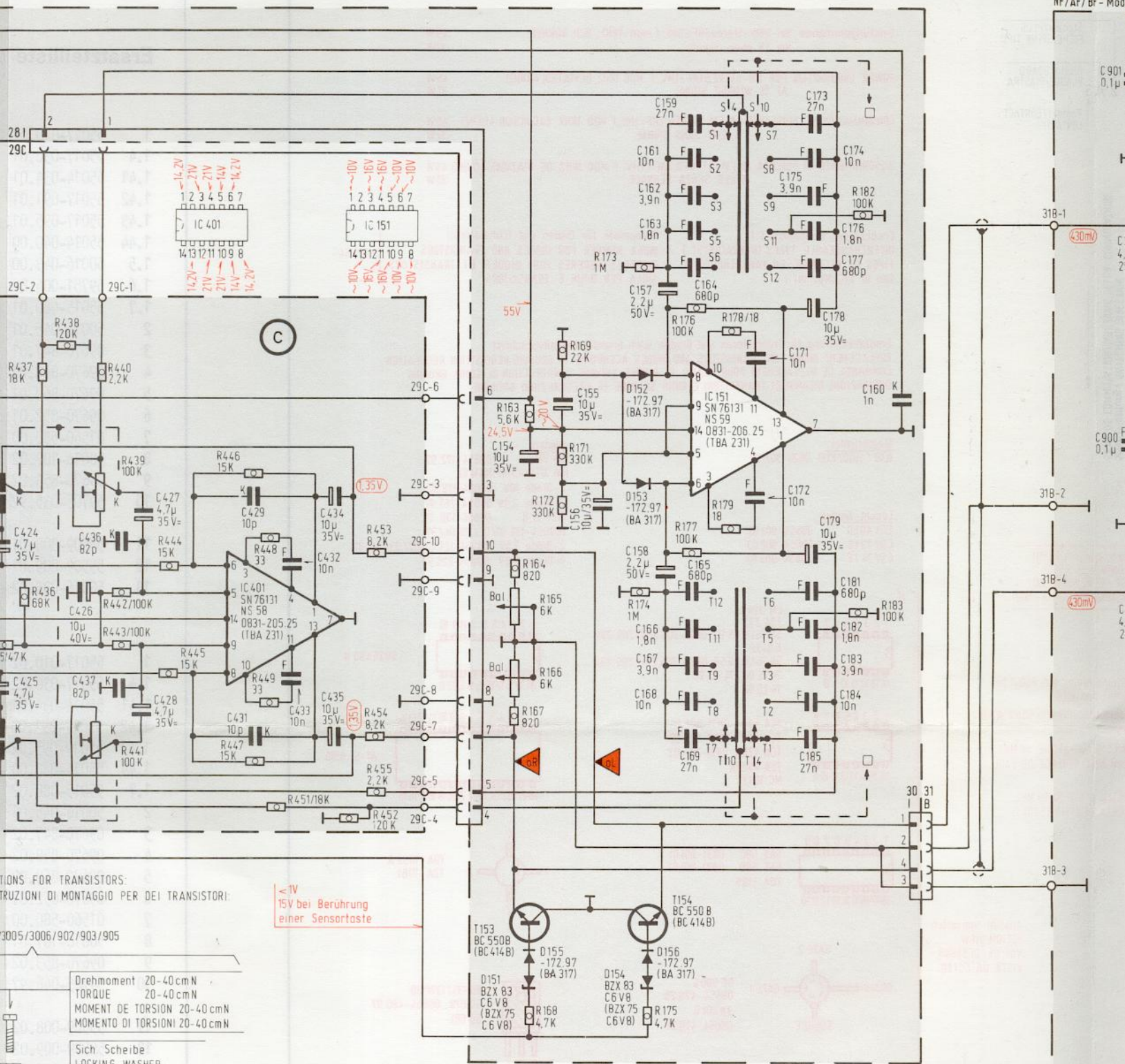

INSTRUCTIONS FOR TRANSISTORS:  
 ISTRUZIONI DI MONTAGGIO PER DEI TRANSISTORI:

3005/3006/902/903/905

Drehmoment 20-40 cmN  
 TORQUE 20-40 cmN  
 MOMENT DE TORSION 20-40 cmN  
 MOMENTO DI TORSIONI 20-40 cmN

Sich Scheibe  
 LOCKING WASHER  
 CIRCLIP  
 RONDELLA DI SICUREZZA

TRANSISTOR

Kühlkörper  
 COOLING PLATE  
 TOLE DE REFROID  
 DISSIPATORE TERMICO

< 1V  
 15V bei Berührung  
 einer Sensortaste

P12 bestreichen (Wacker-Chemie, München)  
 SILICON GRESE P12 (WACKER-CHEMIE, MÜNCHEN)  
 LA GRAISSER P12 (WACKER-CHEMIE MÜNCHEN)  
 AMBO LE PARTI DI GRASSO AL SILICONI P12 (WACKER-CHEMIE, MÜNCHEN)



(B)  
 59311-037.00

424, 425,	426, 437,	436, 438,	427, 428,	429, 431,	432, 433,	434, 435,	154,	155,	156,	157, 158, 162, 165, 168, 172,	159, 163, 166, 169,	164, 167, 171,	162, 165, 168, 172,	173, 174, 175, 176, 177, 179,	178, 181, 184,	179, 183, 182, 185,	180,	182, 183,
433, 435, 434,	436, 437, 441,	438, 440, 443, 441,	442, 445,	444, 445,	446, 447, 449, 451,	448, 449, 451,	452, 454, 455,	453, 454, 455,	164, 165, 166, 167, 168, 169, 170,	163, 164, 165, 166, 167, 168, 169, 170,	173, 174, 175, 176, 177, 178, 179,	175, 176, 177, 178, 179,	173, 174, 175, 176, 177, 178, 179,	176, 177, 178, 179,	182, 183,	182, 183,	182, 183,	

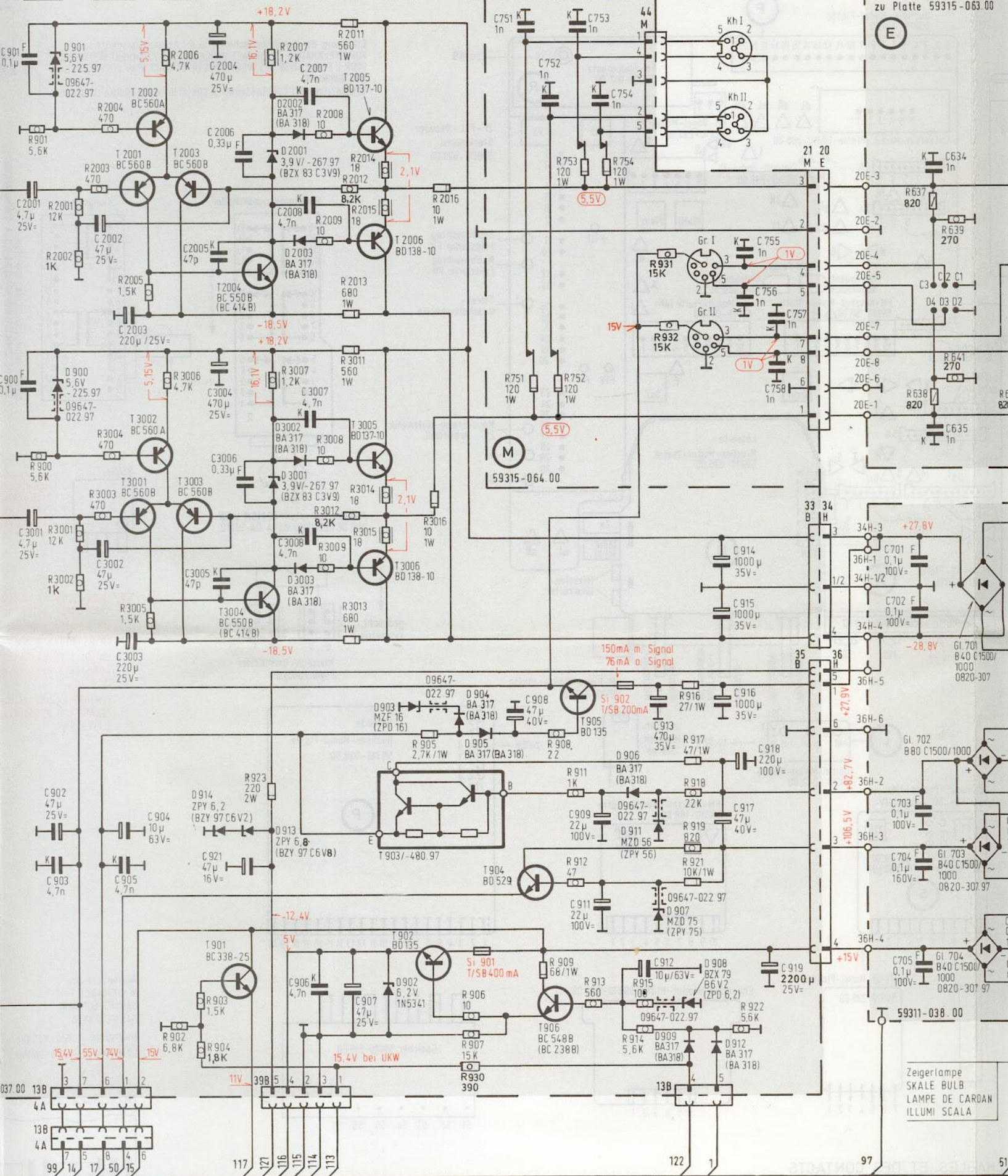

(M)  
59315-064.00

(E)

Zeigerlampe  
SKALE BULB  
LAMPE DE CARDAN  
ILLUMI. SCALA

901, 3001, 2001, 902, 900, 903,	2002, 2003, 3002, 3003, 904, 905,	2004, 3005, 923, 2005, 2006, 3004, 3006,	2007, 3008, 907, 2008, 906, 3007,	908, 751, 752, 753, 754, 909, 911,	912, 913, 914, 917, 755, 919, 757, 915, 918, 756, 758, 916,	635, 703, 701, 704, 634, 702, 705,
901, 2001, 3002, 2004, 2005, 2006, 903, 900, 2002, 2003, 3004, 3005, 3006, 904, 3001, 3003,	902,	902,	923,	751, 752, 753, 754, 909, 908, 912, 911, 913,	915, 931, 916, 919, 922, 914, 932, 917, 921, 918,	637, 639, 638, 641,

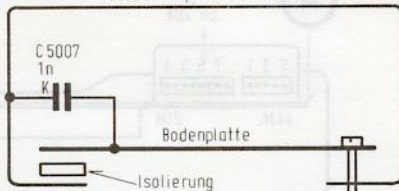
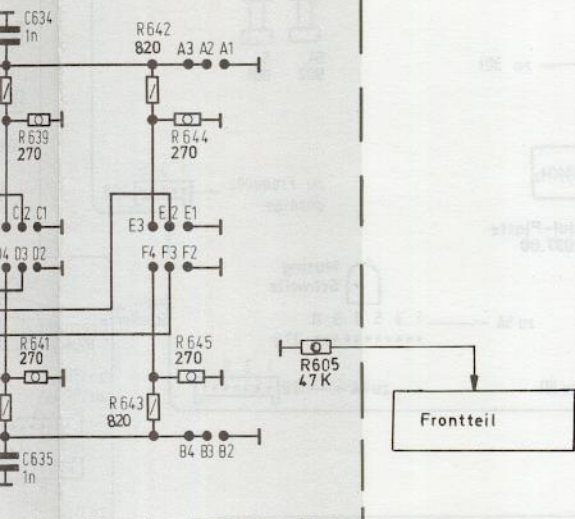

- + Elko
- F Folien Kondensator
- S Styroflex (KS, KP) Kondensator
- K Keramik Kondensator

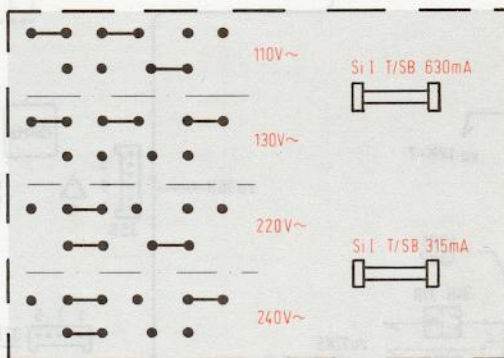

- 0204 DIN
- 0207 DIN
- Rauscharm
- 0309 DIN
- 0411 DIN
- 0414 DIN
- 0617 DIN
- schwer entflammbar
- Metalloxydschicht-widerstand

Trafo-Modul / TRANSFO -MODUL/ELEMENT DE TRANSFO -MODUL/ELEMENTO TRANS -MODULO  
59800-620 00

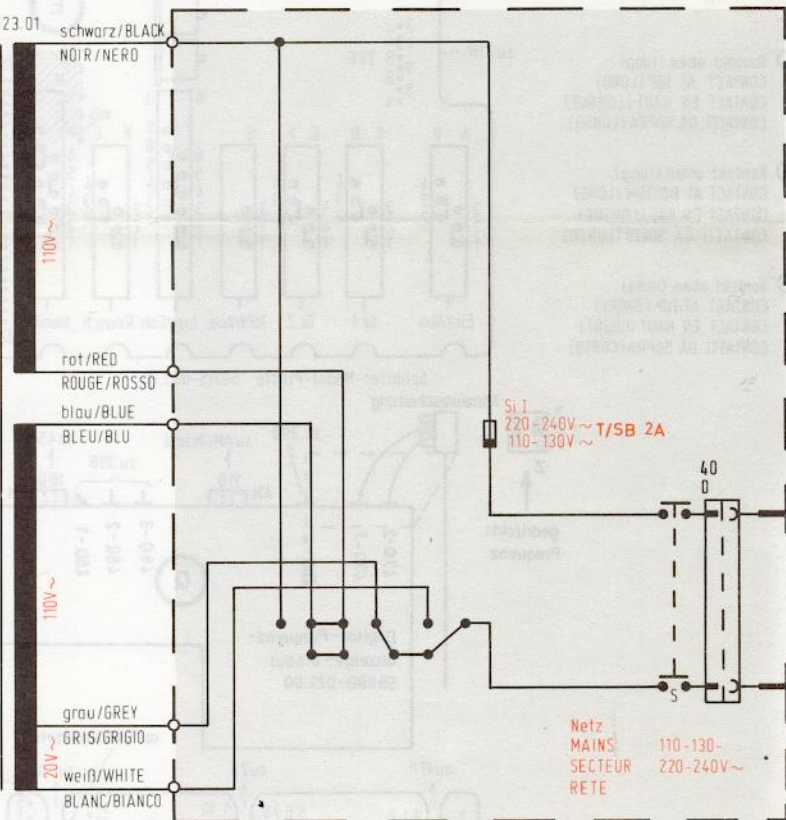
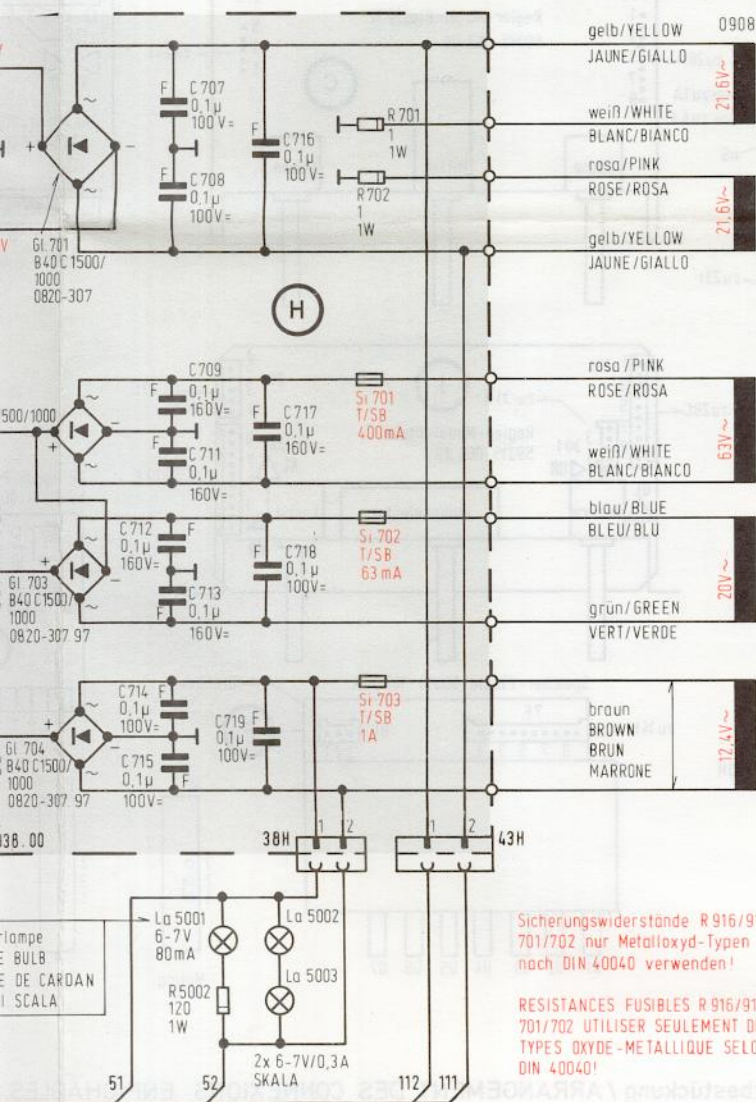

Sicherungswiderstände R 916/917/701/702 nur Metalloxyd-Typen nach DIN 40040 verwenden!

RESISTANCES FUSIBLES R 916/917/701/702 UTILISER SEULEMENT DES TYPES OXYDE-METALLIQUE SELON DIN 40040!

FUSE RESISTANCES R 916/917/701/702 USE ONLY METALLIC-OXIDE TYPES ACC. TO DIN 40040!

RESISTENZA DI SICUREZZA R 916/917/701/702 FORNIBILE SOLO IL TIPO METALLOXID (DIN 40040)!



# Hi Fi PreCeiver X 55

(50019-906.04)

Teil 3

703,	707, 711, 714,	716, 719,	5007,	C
704,	708, 712, 715,	717,		
705,	709, 713,	718,		
37, 639,	642, 644, 5002,	605,	701,	R
38, 641,	643, 645,		702,	

Lautsprecher - Buchsen-Platte  
59315-064.00

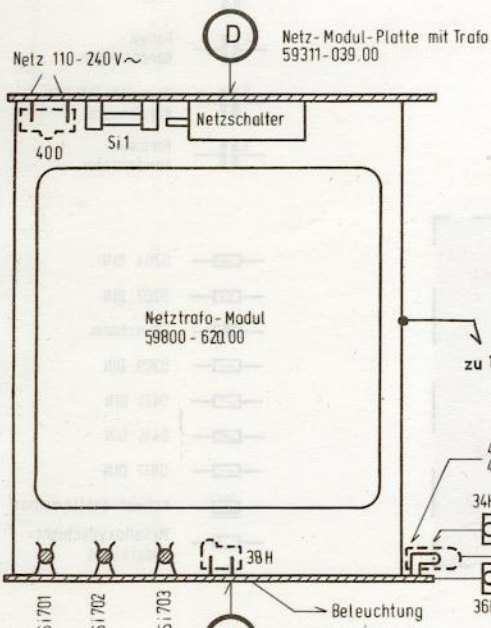

Netz-Modul-Platte sekundär  
59311-038.00

- Kontakt oben (lang)  
CONTACT AT TOP (LONG)  
CONTACT EN HAUT (LONGUE)  
CONTATTI DA SOPRA (LUNGO)
- Kontakt unten (lang)  
CONTACT AT BOTTOM (LONG)  
CONTACT EN BAS (LONGUE)  
CONTATTI DA SOTTO (LUNGO)
- Kontakt oben (kurz)  
CONTACT AT TOP (SHORT)  
CONTACT EN HAUT (COURT)  
CONTATTI DA SOPRA (CORTO)

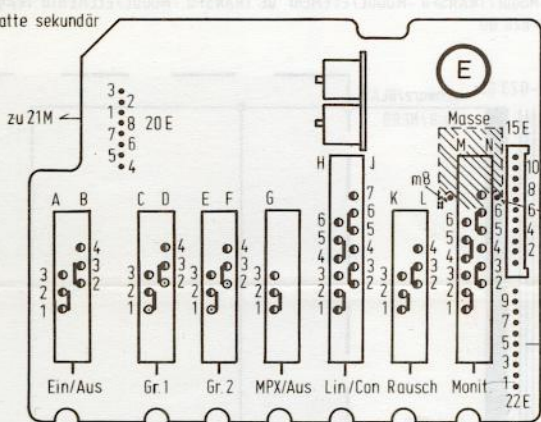

Schalter-Modul-Platte 59315-063.00

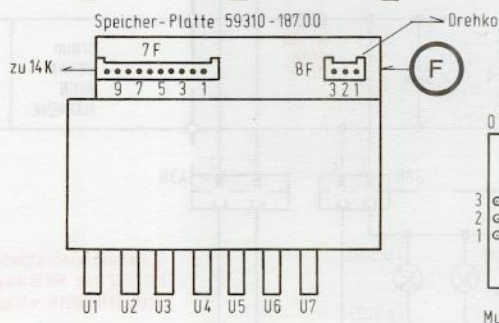
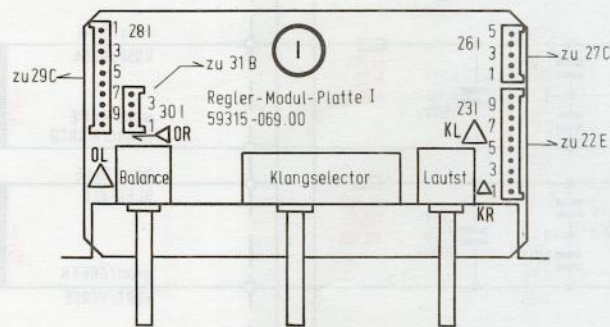
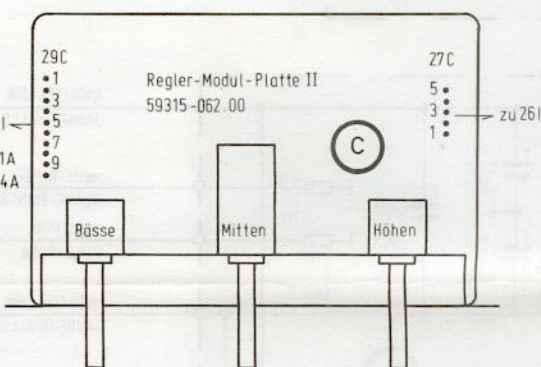
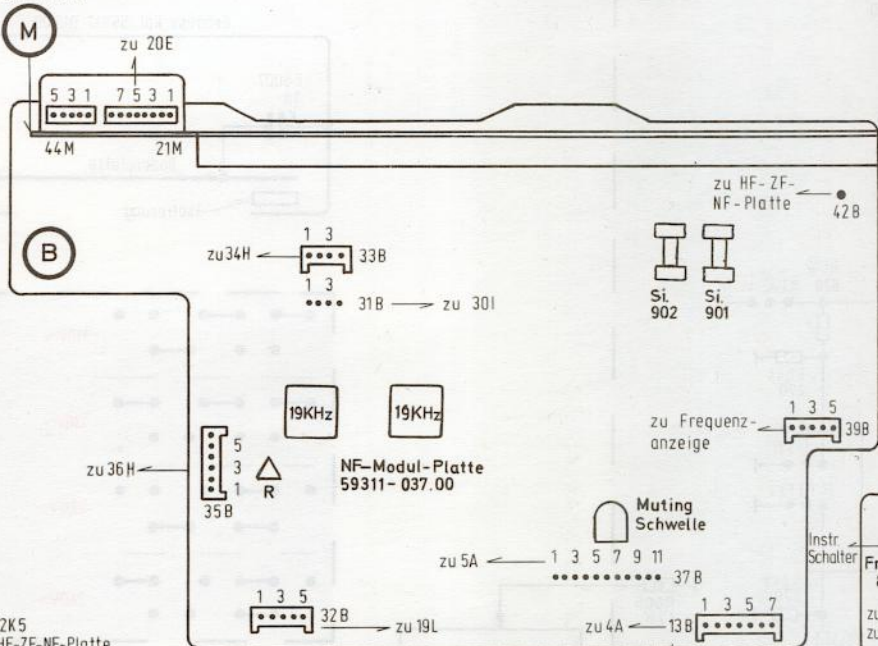
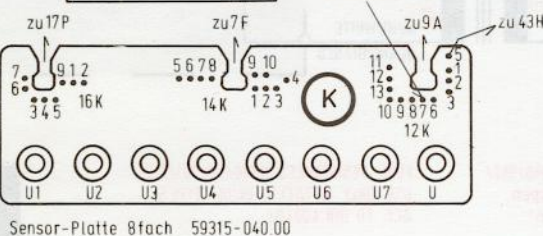
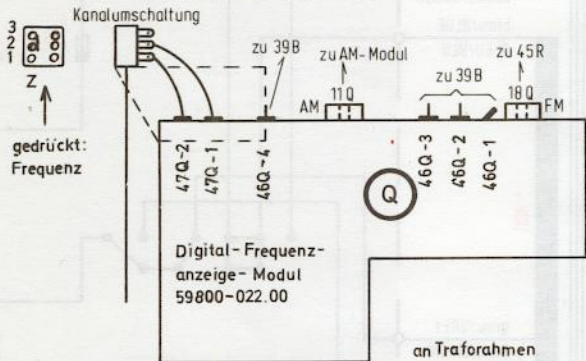

Anderungen vorbehalten  
ALTERATIONS RESERVED  
MODIFICATIONS RESERVEES  
CON RISERVA DI MODIFICA

Lageplan für Steckverbindungen und Kontaktbestückung / ARRANGEMENT DES CONNEXIONS ENFICHABLES  
ARRANGEMENT OF PLUG CONNECTIONS AND CONTACTS / SCHEMA PER COLLEGAMENTI E CONTATTI



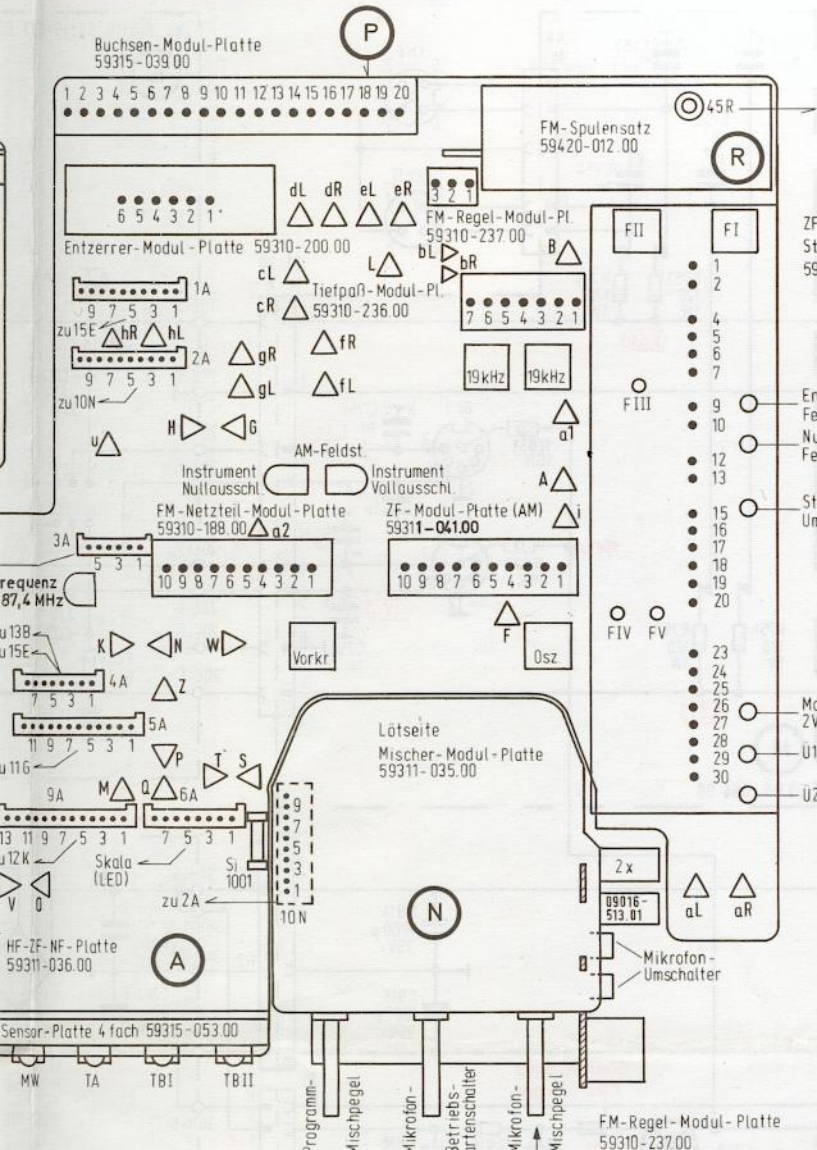

Erklärung der Kontaktbezeichnung in der Abgleichvorschrift:  
 FOR EXPLANATION OF CONTACT INDICATION, SEE ALIGNMENT INSTRUCTIONS.  
 POUR L'EXPLICATION DES INDICATIONS DE CONTACT, VOIR LES INSTRUCTIONS  
 D'ALIGNEMENT.  
 SPIEGAZIONE DEL CONTRASSEGNO DI CONTATTO NELLA NORMA DI TARATURA:

z.B. 2 A3

FII FI

1  
2  
4  
5  
6  
7

FIII

9  
10  
12  
13  
15  
16  
17  
18  
19  
20

FIV FV

23  
24  
25  
26  
27  
28  
29  
30

Endausschlag Feldstärke FM  
 Nullausschlag Feldstärke FM

Mono-Stereo-Automatik 2V Arbeitspkt.  
 U1  
 U2

Mikrofonbetriebsschalter

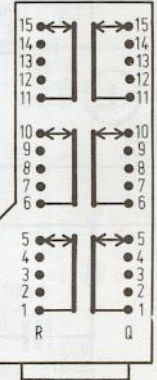

Ansicht von unten / BOTTOM VIEW  
 VUE DE DESSOUS / VISTA DA SOTTO

Klangselector

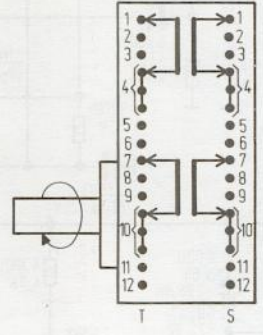

Schalttrichtung / SWITCHING DIRECTION  
 SENSO DI COMUTAZIONE / DIREZIONE DELLA COMMUTAZIONE

R 5001

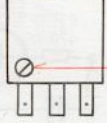

Fußpunktregler  
 BASE CONTROL DIAL  
 REGLAGE DE BASE  
 REGOLAZIONE DI

3,18V = 50mV mit Fußpunktregler  
 Skalenzeiger auf 88 MHz einstellen  
 DIAL POINTER TO 88 MHz ADJUST  
 BASE CONTROL OF R5001  
 L'AIGILLE DU CADRAN SUR LA  
 ADJUSTER 3,18V = 50mV AVEC  
 DE R5001  
 PORTARE L'INDICE DELLA  
 TARARE CON RESISTENZA DI  
 3,18V = 50mV

gedrückt:  
 symmetrisch

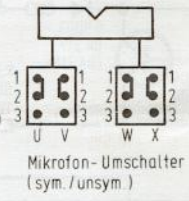

Mikrofon-Umschalter  
 (sym./unsym.)

L

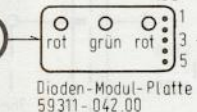

Dioden-Modul-Platte 59311-042.00

FM-Netzteil-Modul-Platte 59310-188.00

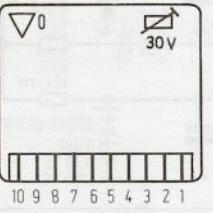

zu 16K

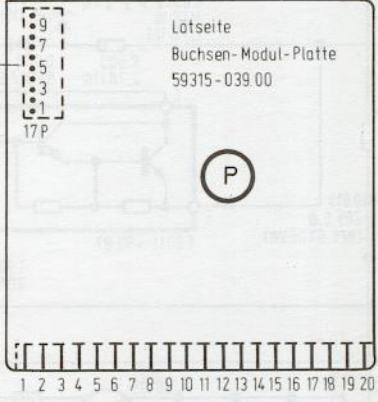

Lötseite Buchsen-Modul-Platte 59315-039.00

ZF-Modul-Platte (AM) 59311-041.00

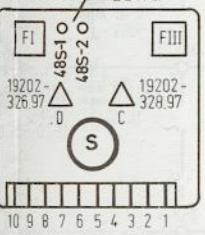

Tiefpaß-Modul-Platte 59310-236.00



Entzerrer-Modul-Platte 59310-200.00

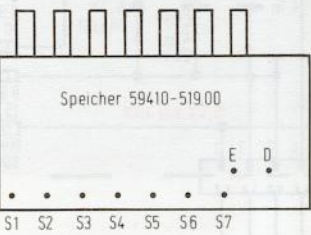
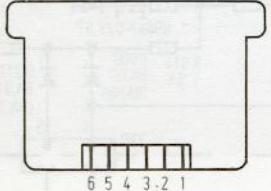

Speicher 59410-519.00

Wellenbereiche  
 WAVE BANDS  
 GAMMES D'ONDES  
 GAMME D'ONDA:  
 MW/PD/OM 510-1620 KHz  
 UKW/FM 87,5-108 MHz

FM-Spulensatz 59420-012.00

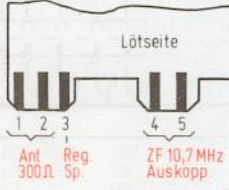

TABLES ET DES CONTACTS  
 TATTI

Stecker/PLUG  
FICHE/SPINE TIPO

Platte/BOARD  
PLAQUE/PIASTRA

Kontakt/CONTACT  
CONTATTI

Schaltrichtung / SWITCHING DIRECTION  
SENS DE COMMUTATION / DIREZIONE DELLA COMMUTAZIONE

Regler von R5001  
CONTROL OF R5001  
RÉGLÉ DE BASE DE R5001  
AZIONE DI BASE DI R5001

Punktregler von R5001 bei  
MHz einstellen  
MHz ADJUST 3,18V ± 50mV WITH  
5001

AN SUR LA MARQUE 88 MHz  
mV AVEC REGLAGE DE BASE

ELLA SCALE SU 88 MHz  
ENZA DI BASE R5001

Ansicht von unten  
BOTTOM VIEW  
VUE DE DESSOUS  
VISTA DA SOTTO

Leistungsaufnahme bei UKW-Stereo (HF=1mV, f mod 1KHz, Hub 40KHz) 45 W  
bei TB ohne Signal 32 W

POWER CONSUMPTION FOR FM-STEREO (RF=1MV, F MOD 1KHZ, DEVIATION 40KHZ) 45 W  
AT TR WITHOUT SIGNAL 32 W

CONSUMATION DE PUISSANCE EN FM STEREO (HF=1MV, F MOD 1KHZ, EXCURSION 40KHZ) 45 W  
A ENR SANS SIGNAL 32 W

ASSORBIMENTO DI POTENZA IN FM-STEREO (AF=1MV, F MOD 1KHZ, DE VIAZIONE 40KHZ) 45 W  
IN REG SENZA SEGNALE 32 W

Ersatztypen in Klammer ( )  
INTERCHANGEABLE TYPES IN BRACKETS ( )  
TYPES DE RECHANGE EN PARENTHESES ( )  
TIPI DI RICAMBI IN ( )

Vornummer für Dioden und Transistoren  
INDEX NUMBER FOR DIODES AND TRANSISTORS  
CHIFFRES REPÈRES POUR DIODES ET TRANSISTORS  
SIGLA PER DIODI E TRANSISTORS

09654-

Ersatzbestellung für Transistoren und Dioden nach Grundig Bestellvorschrift  
REPLACEMENT ORDER FOR TRANSISTORS AND DIODES ACCORDING TO GRUNDIG REQUISITION REGULATION  
COMMANDE DE REMPLACEMENT POUR TRANS ET DIODES SUIVANT L'INSTRUCTION DE COMM GRUNDIG  
ORDINAZIONE RICAMBI DI TRANSISTORI E DIODI SECONDE LE PRESCRIZIONI GRUNDIG

Gleichrichter  
B 40 C 1500/1000 0820-307.97

Leucht-Dioden  
CQY 40LG 09654-901.03  
CQY 72LG 09654-902.03  
CQY 74LF 09654-903.03

Dioden:  
BA 181 09654-172.97  
(BA 317/BA 318/1N4148)  
Z-Diode 10V 09654-178.97  
Z-Diode 3,9V 09654-267.97  
MZF 6,8 09654-139.31  
(09654-139.01/02/03/04/37)  
Z-Diode 7,5V 09654-124.01(02/03/04/31)  
Z-Diode 5,6V 09654-225.97

IC:

LM 374N  
TBA 231  
SN 76131NS 59 0831-206.25 (-205.29)  
S 042P  
SN 76131NS 58 0831-205.25 (-205.29)  
74 LS 00, 74 LS 90  
74 LS 93

TCA 440 0831-204.01  
TCA 530 0831-001.02  
TCA 420A 0831-203.02  
TCA 4500A  
MC 10131

SAS 580 0831-801.01  
SAS 590 0831-801.01  
TDA 1195

BF 900 G 09654-479.25  
3N 201 G 09654-479.31

Transistoren:  
S 6430  
BC 547/548/549/550/558/559/560  
BC 413/414  
BC 237/238  
BC 337/338/328  
BC 308  
BF 414  
BF 936

BF 199  
BF 240  
BF 440/450/495  
BF 254/255

BF 245



SN75498 N



AY-5-8100



TOA 1053 A  
TOA 1061



80 135/137/138  
60 679 09654-480.97  
60 681



80 517  
80 529

Ersatzteilliste (A)

- 1 55017-010.01
- 1.4 55017-030.01
- 1.41 55014-034.01
- 1.42 55017-091.01
- 1.43 55017-095.01
- 1.44 55014-040.00
- 1.5 50016-043.00
- 1.6 59751-004.00
- 1.7 55015-080.01
- 2 50016-045.01
- 3 09670-847.01
- 4 09670-848.01
- 5 09670-860.01
- 6 09670-852.01
- 7 01560-580.00
- 8 50016-107.02
- 9 09670-853.02
- 10 59705-035.97
- 11 55509-008.01
- 12 55509-009.01
- 13 50016-038.02

- 1 55017-010.02
- 1.4 55017-030.02
- 1.41 55014-034.01
- 1.42 55017-091.02
- 1.43 55017-095.02
- 1.44 55014-040.00
- 1.7 55015-080.02
- 2 50016-045.01
- 3 09670-847.02
- 4 09670-848.02
- 5 09670-860.02
- 6 09670-852.02
- 7 01560-580.00
- 8 50016-107.01
- 9 09670-853.02
- 10 59705-046.97
- 11 55509-008.02
- 12 55509-009.02
- 13 50016-038.02



Hi Fi  
PreCeiver X 55  
(50019-906.04)

Gehäuse, metallic			Chassisteile			
10.01	Gehäuse kpl.	26 59500-041.00	2x	Kippschalter kpl. 2-fach/Muting u.AFC	295 59703-123.97	POTE
30.01	Blende	30 59311-305.00		Anzeigeplatte	296 59703-124.97	POTE
34.01	Skalenscheibe	32 09623-081.97	2x	Stereo-Kopfhörerbuchse		KN 5
91.01	Zierrahmen kpl.	35 50016-040.00		Zeigerkappe	297 8383-120-625	Inte
95.01	Zierblech kpl.	36 09612-155.97		ANTRIEBSRAD		SN 7
40.00	Massefeder	39 59701-023.00		2-fach-Drehkondensator kpl.	310 59315-062.00	Regl
43.00	Deckelwanne	40 50016-031.00		Rückwanddeckel	316 59703-125.97	POTE
04.00	Blattfeder	41 50016-081.00		Rollenwinke		KN 5
80.01	Deckel kpl.	42 00813-001.02	8x	Seilrolle	317 59703-127.97	POTE
45.01	Abstimmchlüssel	43 09603-452.00	6x	Hülse		KN 5
47.01	5x Drehknopf	44 09603-456.00	2x	Hülse	318 59703-126.97	POTE
48.01	Drehknopf	45 09612-833.00		SCHWUNGRAD		KN 5
50.01	2x Drehknopf	46 50016-033.00		Lagerplatte	319 8383-120-525	Inte
52.01	Drehknopf	48 8138-005-015		Skalenseil (7x0,1)		SN76
80.00	UKW-Möbelantenne	51 8138-007-021	2x	Antriebsschnur TE 50 P	330 59310-187.00	Spei
07.02	SKALA KPL.	53a 59500-042.00		Schiebefortschalter	331 59410-519.00	Spei
53.02	DREHKNOFF KPL.	53c 50019-032.00		Schalterzunge		
35.97	ANZEIGEINSTRUMENT (Feldstärkem.)	53d 50019-031.00		Knopf	340 59310-188.00	FM-N
08.01	8x Zeigerkappe	68 09690-358.01		Netzleitung kpl.	350 59315-063.00	Scha
09.01	Zeigerkappe m. Mark.	68 09690-358.02		Netzleitung kpl.(f.CH)	351 59500-028.00	Kipp
38.02	ZEIGER	68 09690-358.03		Netzleitung kpl.(f.SK/BE)	353 59500-033.00	Kipp
		68 09690-358.04		Netzleitung kpl.(f.GB)	354 59500-031.00	Kipp
		68 09690-358.05		Netzleitung kpl.(f.Exp.)	355 59500-034.00	3x Kipp
	Gehäuse, schwarz	71 8316-113-009		Lampe 6-7V/0,3A (LA5002/5003)	356 59500-036.00	Kipp
10.02	Gehäuse kpl.	72 8316-453-004		Zwerglampe 7V/80mA (LA5001)	370 55509-008.01	8x Zier
30.02	Blende kpl.	72a 8309-701-107		Zener-Diode BZX83/C5 (D5008)	371 55509-009.01	Zier
34.01	Skalenscheibe	73 8309-990-124		LE-Diode CQY 40 lg. (D5006)		Sens
91.02	Zierrahmen kpl.	74 8309-990-213		LE-Diode CQY 72 lg. (D5004/5005)	380 59315-040.00	Sens
95.02	Zierblech kpl.	75 8309-990-314		LE-Diode CQY 74 lg. (D5007)	381 50016-132.01	Sens
40.00	Massefeder	108 8305-305-059		Integr. Schaltung SAS590 (IC1001)	388 8305-305-058	Inte
80.02	Deckel kpl.	109 8305-302-195		Integr. Schaltung TDA1195 (IC1002)	389 8305-305-059	Inte
45.01	Abstimmchlüssel	128 19799-323.91		Trimmer 3/15pF (C1027)	390 8309-990-213	7x LE-D
47.02	5x Drehknopf	129 19799-323.97		Trimmer 3/15pF (C1026)	400 59315-039.00	Buch
48.02	Drehknopf	131 8790-009-244		Einstellregler 3KΩ (R1083)	401 09622-388.02	5x Zwer
50.02	2x Drehknopf	132 8790-009-238		Einstellregler 2KΩ (R1021)	402 09625-475.00	Ante
52.02	Drehknopf	134 8790-009-280		Einstellregler 2MΩ (R1079)	406 09623-104.97	Mehr
80.00	UKW-Möbelantenne	150 59420-012.00		FM-Spulensatz	420 59311-041.00	ZF-M
07.01	SKALA KPL.	175 59310-238.00		FM-Spulen-Platte	421 19202-326.97	ZF-F
53.02	DREHKNOFF KPL.			ZF-PLL-Decoder-Steckmodul	422 19202-328.97	ZF-F
36.97	ANZEIGEINSTRUMENT (Feldstärkem.)	190 59800-621.00		Einstellregler 10KΩ (R25)	424 19203-036.97	Ker.
08.02	8x Zeigerkappe	212 8790-006-248		Einstellregler 5KΩ (R56)	440 59310-200.00	Entz
09.02	Zeigerkappe m. Mark.	213 8790-009-251		Einstellregler 10KΩ (R41)		
38.02	ZEIGER	214 8790-009-010		Einstellregler 1KΩ (R18)	450 59311-035.00	Misch
		215 8790-009-026		Einstellregler 250KΩ (R13/45)	451 59500-020.00	Dreh
		216 8700-201-057		Widerstand B 0207 NB/220Ω (R3/4)	462 59703-129.97	POTE
		230 59310-236.00		Tiefpaß-Modul-Platte kpl.	463 59703-128.97	KN 5
		240 59310-237.00		FM-Regel-Modul-Platte kpl.		POTE
		243 8790-209-261		Einstellregler 220KΩ (R492)	464 59310-234.00	KN 5
		250 59315-053.00		Sensor-Platte kpl.	464.1 09623-093.01	Mikro
		251 50016-131.01		Sensor-Leiste 4-fach	464.2 59500-023.00	2x Min.-
		252 8309-990-213		LE-Diode CQY 72 lg. (D10...13)	464.3 50016-130.00	Tande
		255 59311-042.00		Dioden-Modul-Platte kpl.	464.4 09016-513.01	2x Mikro
		290 59315-069.00		Regler-Modul-Platte I kpl.	530 59315-064.00	Laut
		294 59500-021.00		DREHSCHALTER (Lautstärke)		

				<u>Netztrafo-Modul</u>	
POTENTIOMETER 2x100KΩ (R151/152)	540	59800-620.00	Netztrafo-Modul kpl.		
KN 53123 (Lautstärke)	548	8308-528-004	GLEICHRICHTER	(G1.703/704/701)	
POTENTIOMETER 2x6KΩ (R165/166)			B40/C1500/1000		
KN 53124 (Balance)	548	8308-538-017	GLEICHRICHTER	(G1.702)	
Integr. Schaltung (IC151)			B80/C1500/1000		
SN 76131 NS 59	551	09622-961.00	Zugschalter kpl. 2-pol.		
Regler-Modul-Platte II kpl.	552	00813-001.01	Seilrolle		
POTENTIOMETER 2x200KΩ (R406/407)	555	09088-006.01	NETZTRAFO		
KN 53125 (Bass)					
POTENTIOMETER 2x100KΩ (R403/411)					
KN 53127 (Höhen)	570	59800-022.00	<u>Digital-Frequenzanzeige-Modul</u>		
POTENTIOMETER 2x100KΩ (R433/434/439/441)			Dig.-Frequenz-Modul kpl.		
KN 53126 (Klangselector)	570	59800-022.01	(f.metallic Ausf.)		
Integr. Schaltung (IC401)			Dig.-Frequenz-Modul kpl.		
SN76131 NS 58	571	59800-026.00	(f.schwarze Ausf.)		
Speicher-Platte kpl.	572	59800-027.01	Kontrastscheibe		
Speichereinheit 7-fach	572	59800-027.02	Blende(f.metallic Ausf.)		
FM-Netzteil-Mod.Platte kpl.	573	09621-118.00	Blende (f.schwarze Ausf.)		
Schalter-Modul-Platte kpl.	574	59800-034.01	Steckerbuchse		
Kippschalter kpl. 2-fach(Aus)	579	8382-241-197	Koaxialbuchse		
Kippschalter kpl. 2-fach(MPX)	580	8305-196-000	Quarz 5,12MHz	(Q1)	
Kippschalter kpl. 4-fach(Lin./Cont.)	581	8305-196-093	Integr. Schaltung	(IC7)	
Kippschalter kpl. 2-fach(Rausch)(L1/2)			N74 LS 00A		
Kippschalter kpl. 4-fach(Monitor)	582	8305-200-598	Integr. Schaltung	(IC5/6)	
Zierkappe	583	8305-205-210	N74 LS 93 A		
Zierkappe m. Mark.	584	8305-196-090	Integr. Schaltung	(IC 2)	
Sensor-Platte kpl. 8-fach	585	8309-505-044	SN 75498 N		
Sensorleiste 8-fach	595	59315-058.00	Integr. Schaltung	(IC 1)	
Integr. Schaltung SAS580 (IC 1)	598	59315-059.00	MC 10131		
Integr. Schaltung SAS590 (IC 2)	598.1	19799-142.97	Integr. Schaltung	(IC3/4)	
LE-Diode CQY 72 lg.			N74 LS 90 A		
Buchsen-Modul-Platte kpl.			Thyristor TIC 44	(TH 1...4)	
Zwergsteckdose			IC-Platte kpl.		
Antennenbuchse kpl.			Display-Platte kpl.		
Mehrfachbuchse 10-pol.			LED-Displaysatz	(LED 1...4)	
ZF-Modul-Platte kpl.(AM)					
ZF-Filter kpl.					
ZF-Filter kpl.					
Ker.-Filter 460KHz					
Entzerrer-Modul-Platte kpl.					
Mischer-Modul-Platte kpl.					
Drehschalter					
POTENTIOMETER 2x50KΩ (R6019/6021)					
KN 53129/Mix					
POTENTIOMETER 2x50KΩ (R6056/6057)					
KN 53128 (Mikrofon)					
Mikrofon-Buchsen-Platte					
Mikrofonbuchse					
Min.-Schiebefortschalter					
Tandem-Knopf					
Mikrofon-Übertrager kpl.					
Lautsprecher-Buchsenplatte kpl.					



01005-10-11-10  
 02008-10-11-10  
 10-10-10-3011A10  
 10-11-10-ANT10